

Stamps
ink pads
DECALS
Labels
magnets
Seals
PENS
Numberers
photo
gifts
DECALS
Banners
signage
DATERS
Sticky
Notes
bonds
TUMBLERS
Handbooks
name
badges
EMBOSSERS
Letterhead
business
cards
GIFT ITEMS
Nameplates
rubber stamps

custom
PROFESSIONAL
MARKETING

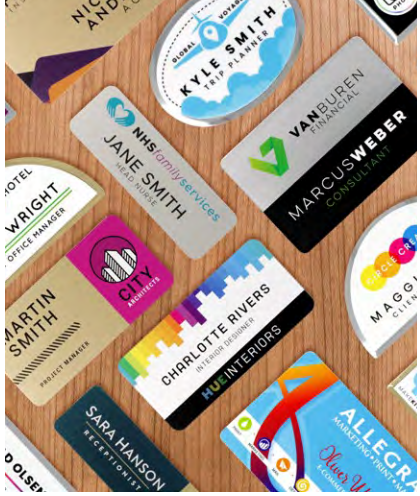

RUBBERSTAMP & SIGN CATALOG

THEPRINTSHOP

WWW.THEPRINTSHOP.NET

REV 5-2024

Table of Contents



CUSTOM STAMPS	3
ExcelMark Pre-Inked Stamps.....	3
XStamper Pre-Inked Stamps.....	5
XStamper Specialty Stamps.....	6
XStamper Pocket Stamps.....	6
XStamper Industrial Custom Stamps.....	7
Superslim and Slim Stamp Pocket Stamps.....	8
ExcelMark Self-Inking Stamps.....	9
ANTIbac Self-Inking Stamps.....	10
Shiny Handy Self-Inking Stamps.....	10
Trodat Printy Self-Inking Stamps.....	11
Trodat Professional Self-Inking Stamps.....	12
Rubber Stamps.....	13

DATE STAMPS + NUMBERERS..... **15**

ExcelMark Date Stamps.....	15
ExcelMark Stock Message Date Stamps.....	16
Trodat Dater / Stock Message Series.....	16
Trodat Professional Daters.....	17
Trodat Printy Line & Round Daters.....	18
XStamper Stock Xpe Daters.....	19
XStamper XpeDater Date Stamps.....	20
XStamper VersaDater Pre-Inked Date Stamps.....	20
XStamper Date Stamps.....	21
XStamper Line Daters.....	21
XStamper Stamp Trays.....	21
Trodat Classic Line Date.....	22
Trodat Die Plate Daters and Numberers.....	22
Trodat Classic Dater.....	23
Trodat Classic Die Plate Daters.....	23
Trodat Classic Numberers.....	24
Trodat Professional Self-Inking Numbering Stamps.....	25
Trodat Printy Numberers.....	25
Automatic Numbering Machines	
Econo Numbering Machine.....	26
Standard Numbering Machine.....	26
Deluxe Numbering Machine.....	26

STOCK STAMPS..... **27**

Pre-Inked or Self-Inking Stock Stamps.....	27
Mini Stock Stamps.....	28
Plastic Stock Message Stamps.....	28
Identity Theft Guard Stamps.....	28

NOTARY + PROFESSIONAL..... **29**

Notary Stamps & Embossers.....	29
Notary Supplies.....	30
Professional Stamps.....	31
Professional Corporate Kits.....	31
Embossers.....	32
Seal Inker.....	32
Gold Foil Seals.....	32

NAME BADGES..... **33**

Classic Engraved Badges.....	33
Designer Engraved Badges.....	34
Framed Engraved Badges.....	34
Full Color Plastic Badges.....	35
Full Color Aluminum Badges.....	36
Framed Full Color Badges.....	36
Designer Full Color Badges.....	37
Pocket Badges.....	37
Metal Uniform Badges.....	37
Reusable Message Badges.....	38
Photo ID Badges.....	38
Badge Accessories.....	38

NAMEPLATES..... **39**

Wall Fasteners.....	39
Nameplate Inserts.....	39
Nameplate Holders.....	40
Plastic Desk Bars.....	41
Designer Desk Wedges.....	41
Acrylic Nameplates.....	42
Sandblasted Glass Nameplate.....	42

SIGNAGE..... **43**

Custom Engraved Plastic Signage.....	43
Corridor Signs.....	44
Full Color Signage.....	45
Appliqué Signage.....	46
3D Printed Signage.....	46
Interior Signage Types.....	47-48
Signage Collections.....	49-52
Stock ADA Signs.....	53
Classic Engraved Stock Signs.....	54
Custom Signage Design Options.....	55
Layout Templates.....	56
Copy Styles.....	57
Symbol Options.....	58
Color Charts.....	59-60

STAMP INK + PADS..... **61**

Trodat Replacement Pads.....	61
Excelmark Replacement Pads.....	61
Shiny Replacement Pads.....	61
Aero Ink & Mark II Pads.....	61
Standard Ink Pads.....	62
Standard Marking Inks.....	62

FLOOR + WALL DECALS..... **63**

Floor and Wall Decals.....	63-64
----------------------------	-------

Pre-Inked Stamps

- Sharp, high-quality, crisp impressions
- Re-inkable
- Pre-inked for up to 20,000 impressions
- *Lifetime guarantee*

Available Colors

- Black
- Red
- Blue
- Green
- Purple

ExcelMark

ExcelMark Pre-Inked Stamps

Item #	Impression Area	Max. # of Lines
XL3-55E	1/8" x 2 3/8"	1
XL3-125E	7/8" x 1 7/8"	6
XL3-165E	1 3/8" x 2 3/8"	10
XL3-185E	7/8" x 2 11/16"	6
XL3-245E	1 1/4" x 3 5/16"	8
XL3-265E	1/2" x 3 1/8"	3
XL3-275E	1 3/4" x 3 3/4"	10
XL3-750E	1 5/8" x 4 7/8"	10
XL3-1444	1" x 1 3/4"	4
XL3-3535E	1 3/8" x 1 3/8"	7
XL3-5050E	1 7/8" x 1 7/8"	12
XL3-800E	3" x 4 5/16"	18
XL3-305E	5/16" Diameter	2
XL3-325E	1/2" Diameter	3
XL3-495E	1 1/16" Diameter	5
XL3-535E	1 1/2" Diameter	9
XL3-655E	2" Diameter	12

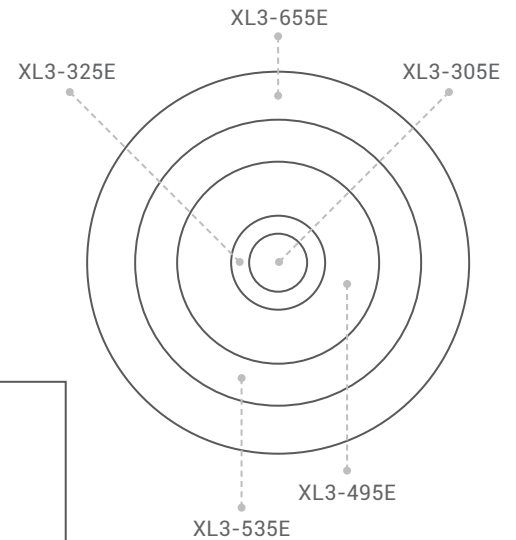
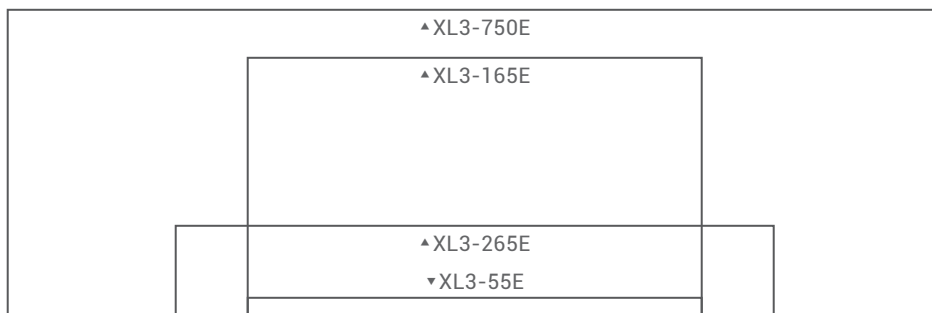
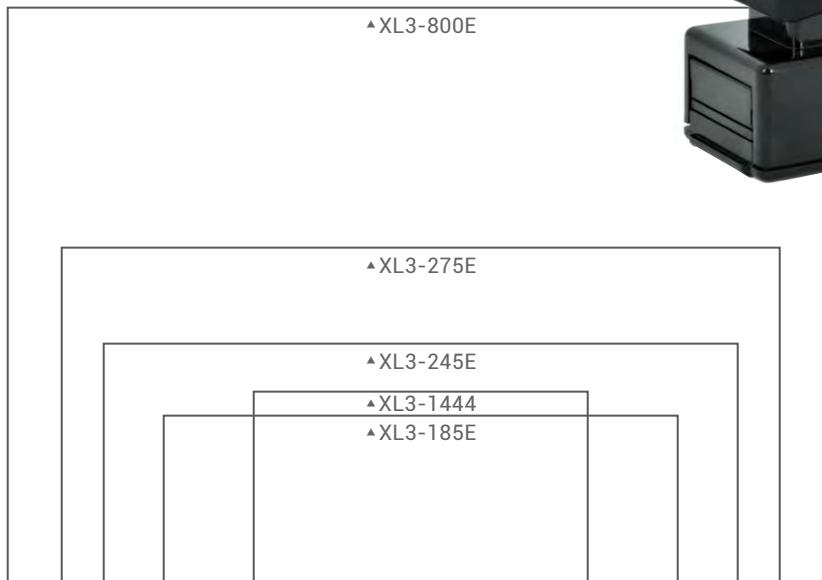
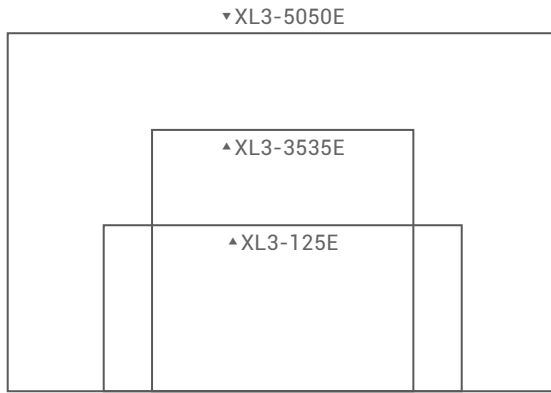

ExcelMark Modico

ExcelMark Modico Pre-Inked Stamps

Item #	Impression Area	Max. # of Lines
E20	$\frac{7}{16}$ " x $1\frac{7}{16}$ "	2
E30	$\frac{9}{16}$ " x $1\frac{15}{16}$ "	3
E50	$\frac{7}{8}$ " x $2\frac{1}{2}$ "	6
E60	$1\frac{5}{16}$ " x $2\frac{1}{2}$ "	9
E100	$1\frac{3}{4}$ " x $3\frac{1}{2}$ "	9
E120	$2\frac{7}{16}$ " x $3\frac{1}{8}$ "	16
E140	$2\frac{11}{16}$ " x $3\frac{3}{8}$ "	16
E25	$\frac{7}{8}$ " Diameter	4
E45	$1\frac{5}{8}$ " Diameter	9
Q40	$1\frac{5}{8}$ " x $1\frac{5}{8}$ "	10

Features a **SLEEK EURO** Design!

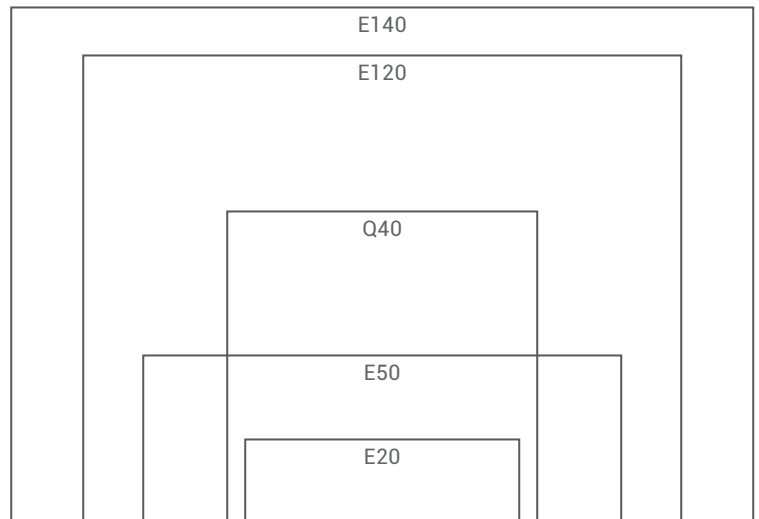
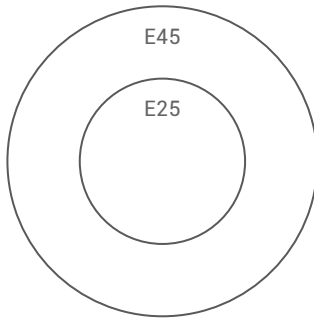

ExcelMark Made in the USA



MADE IN THE
USA
 IN
milwaukee
WISCONSIN
 BY A SMALL
Family Owned Business

- Re-inkable with ExcelMark Flash Ink (2cc Only).

ExcelMark Made in the USA Pre-Inked Stamps

Item #	Impression Area	Max. # of Lines
FL1640	$\frac{5}{8}$ " x $1\frac{9}{16}$ "	5
FL2560	$1\frac{15}{16}$ " x $2\frac{5}{16}$ "	6

Xstamper



- Pre-inked for an initial 50,000 impressions.
- Re-inkable.
- Ergonomic ABS plastic handle is designed for durability.
- Stamp material is laser engraved to provide a perfect impression every time.
- Our ECO-GREEN mounts are made from at least 50% post-consumer content.

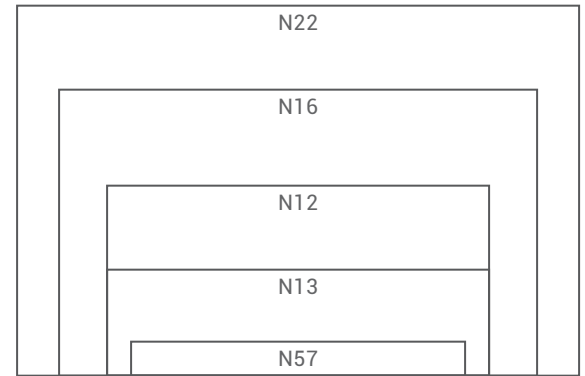
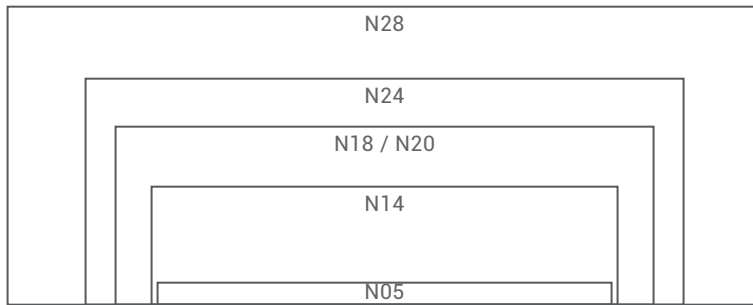
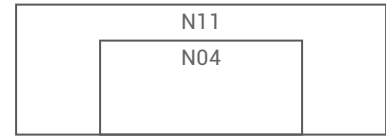
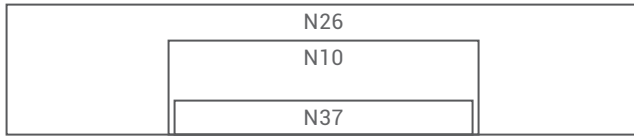

Xstamper Pre-Inked Custom Stamps

Item #	Impression Area	Max. # of Lines
N04	1/2" x 1 1/16"	4
N05	1/8" x 2 3/8"	1
N10	1/2" x 1 5/8"	4
N11	1 1/16" x 1 15/16"	6
N12	1" x 2"	9
N13	9/16" x 2"	5
N14	5/8" x 2 7/16"	5
N16	1 1/2" x 2 1/2"	13
N18	15/16" x 2 13/16"	7
N20	15/16" x 2 13/16"	7
N22	1 15/16" x 2 15/16"	17
N24	1 3/16" x 3 1/8"	10
N26	1 1/16" x 3 5/16"	6
N27	1 9/16" x 3 15/16"	13
N28	2 9/16" x 3 15/16"	22
N30	3/8" Diameter	2
N32	5/8" Diameter	3
N37	3/16" x 1 9/16"	1
N48	3/4" Diameter	3
N49	1 3/16" Diameter	5
N51	15/16" Diameter	4
N53	1 9/16" Diameter	7
N56	15/16" x 15/16"	8
N57	3/16" x 1 3/4"	6

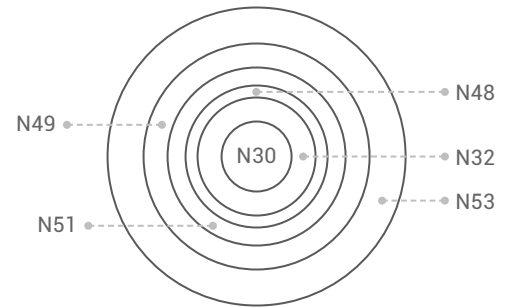

Xstamper Specialty Stamps

- These stamps have unique mounts which make them ideal for Inspection and Quality-Control tasks.



N37

Xstamper Pre-Inked Custom Specialty Stamps

Item #	Impression Area	Max. # of Lines
N06	¼" Diameter	1
N30	⅜" Diameter	2
N37	⅜" x 1 ⅙"	1
N44	⅜" Diameter	3
N47	1 ⅜" Diameter	5
N60	½" Diameter	3
N70	½" x 2"	4
N71	Individual Impression Cartridge	

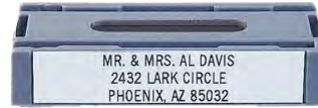

N70



N30



N44



N60

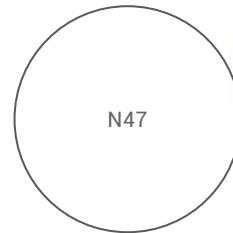

N47



Fits into the end of a pen or pencil!



Xstamper Pocket Stamps

- This stamps handle is also a very handy carrying case.
- Won't leak in a pocket or purse so it's great on the go.



N40 / PN40



N42

A portion of the proceeds go to the Susan G. Komen for The Cure

Xstamper Pre-Inked Custom Pocket Stamps

Item #	Impression Area	Max. # of Lines
N40	½" x 2"	4
PN40	½" x 2"	4
N42	⅝" x 2 ⅞"	5

Xstamper Industrial Custom Stamps

- Make your mark almost anywhere with pre-inked Industrial Stamps from Xstamper.
- Xstamper pre-inked industrial stamps use an ink formulation that is fast drying, permanent and water resistant when fully cured.
- Ideal for marking any slick or hard to mark surface such as metal, glass, leather, and glossy paper.
- Default ink color is Black.

Available Ink Colors

- Black
- Red
- Blue
- Green
- White
- Purple
- Yellow

White and Yellow are opaque inks and will still show on dark surfaces.



F30



F11



F6



F10



F16



F20

Xstamper Industrial Stamps

Item #	Impression Area	Max. # of Lines
F06	1/4" Diameter	1
F10	1/2" x 1 5/8"	4
F11	1/2" Diameter	3
F16	5/8" Diameter	3
F20	3/4" Diameter	3
F30	1 3/16" Diameter	5

Laser-Engraved Silicone Rubber



Air Tight O-Ring Seal

Superslim Pocket Stamps

- The ultimate in convenience!
- Features an even slimmer, more compact design than the Slim Stamp.
- These high-quality, durable stamps can be taken anywhere thanks to their portable size and compact design.
- Superslim delivers the same crisp impressions as their larger, traditional pre-inked counterparts.

COMPACT MOUNT
designed to be carried with you.

Superslim Pre-Inked Stamps

Item #	Impression Area	Max. # Of Lines
FL1442	7/16" x 17/16"	3
FL2054	9/16" x 1 13/16"	4
FL2564	7/8" x 2 3/8"	6

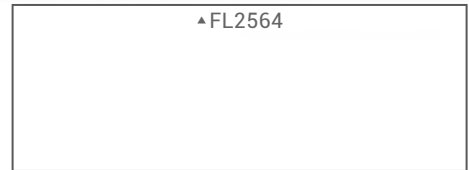
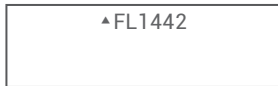

Slim Stamp Pocket Stamps

- It's compact design is ideal for anyone on the move.
- Uses 80% less plastic and create 3 to 5 times the number of impressions of a traditional self-inker.
- A double bonus... using Slim Stamp as your everyday stamp not only reduces the amount of plastic that ends up in landfills, the printing portion can be replaced indefinitely as well, resulting in less pollution.

Slim Stamp Pre-Inked Stamps

Item #	Impression Area	Max. # Of Lines
FL1444	1 1/16" x 1 15/16"	6
FL1854	7/8" x 2 3/8"	6
FL2264	1" x 2 5/8"	6
FL2773	1 1/8" x 3"	7
FL3679	1 1/2" x 3 1/4"	8
FL4141	1 3/4" x 1 3/4"	10
FL50R	2" Diameter	12

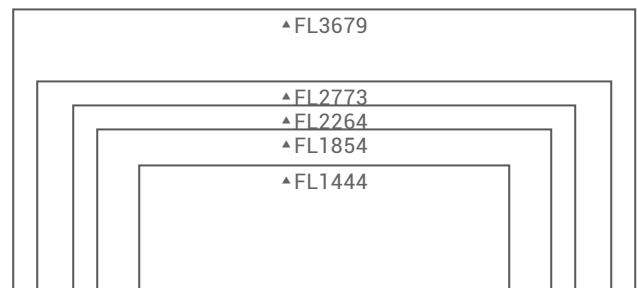

Self-Inking Stamps

- Attractive, clear mount which allows you to accurately line up your stamp impression
- Ideal for rapid, repetitive stamping
- Re-inkable

Available Colors

- Black ● Red ● Blue
- Green ● Purple ● Brown

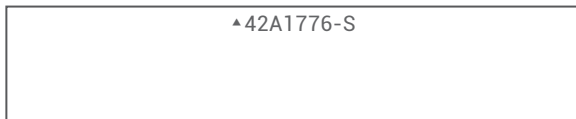
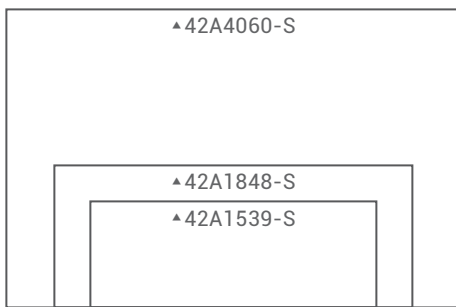
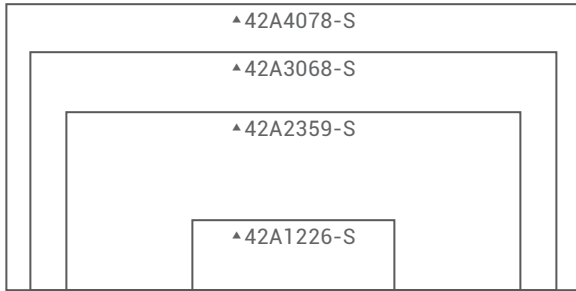

ExcelMark Self-Inking Stamps

- Clear, crisp impression.
- See-through base makes lining up the impression easier.
- Available in a wide range of imprint shapes and sizes.
- Self-inking design allows for quick, repetitive stamping.
- Re-ink the ink pad when dry with ExcelMark refill ink.

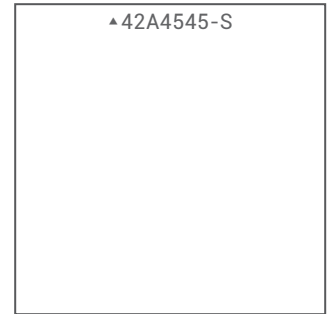
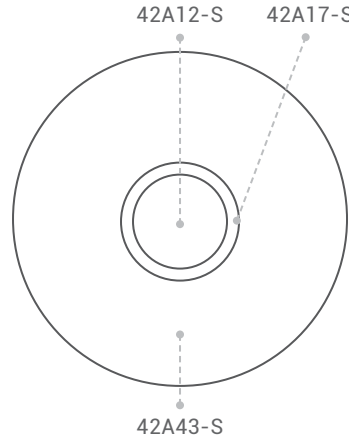

ExcelMark Self-Inking Stamps

Item #	Impression Area	Max. # of Lines	Replacement Pad
42A1226-S	3/8" x 1 1/16"	2	46A1226-S
42A1539-S	9/16" x 1 1/2"	3	46A1539-S
42A1776-S	5/8" x 3"	3	46A1776-S
42A1848-S	3/4" x 1 7/8"	5	46A1848-S
42A2359-S	15/16" x 2 3/8"	5	46A2359-S
42A3068-S	1 1/4" x 2 3/4"	7	46A3068-S
42A4060-S	1 5/16" x 2 3/8"	9	46A4060-S
42A4078-S	1 1/2" x 3"	9	46A4078-S
42A4545-S	1 5/8" x 1 5/8"	9	46A4545-S
42A12-S	1/2" Diameter	3	46A12-S
42A17-S	5/8" Diameter	4	46A17-S
42A43-S	1 3/4" Diameter	9	46A43-S
42099	Signature	N/A	46000-S

Shiny ANTibac Stamps

- ANTibac stamps have been treated with a fungistatic agent which kills up to 99.99% of the bacteria that come into contact with the stamp.

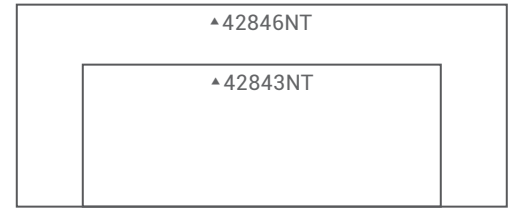
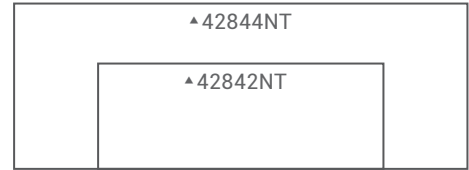

ANTibac Self-Inking Stamps

Item #	Impression Area	Max. # of Lines	Replacement Pad
42842NT	9/16" x 1 1/2"	3	46842
42843NT	3/4" x 1 7/8"	4	46843
42844NT	7/8" x 2 3/8"	4	46844
42846NT	1 1/16" x 2 9/16"	6	46846

Shiny Handy Stamps

- Portable yet durable and great when stamping on the go is necessary.
- Designed to fold away when the stamp is not being used.
- The unique design makes handling easy as it can be operated with one hand.

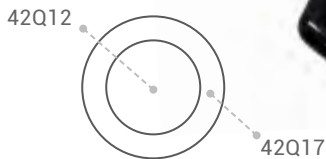

Shiny Handy Self-Inking Stamps

Item #	Impression Area	Max. # of Lines	Replacement Pad
42Q12	1/2" Diameter	3	46Q12
42Q17	3/4" Diameter	4	46Q17
42S722	9/16" x 1 1/2"	3	46S722
42S723	3/4" x 1 7/8"	4	46S723

Trodat Printy Self-Inking Stamps

- Available in a wide range of imprint shapes and sizes.
- Easy and clean ink cartridge change.
- Outstanding impression quality.
- Ergonomically designed to fit perfectly in the hand.
- Eco-friendly - most sizes are Climate Neutral.

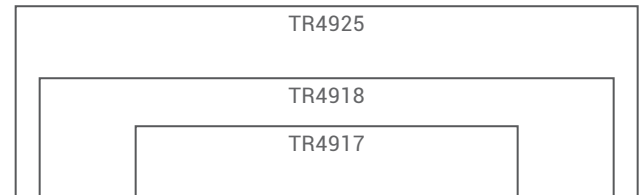
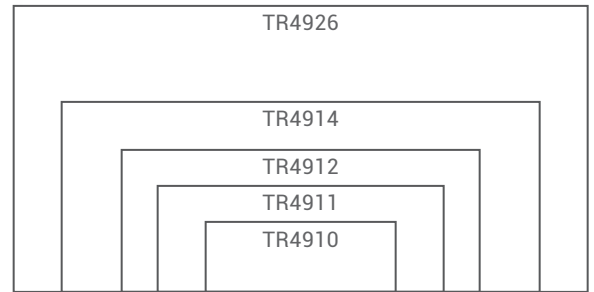
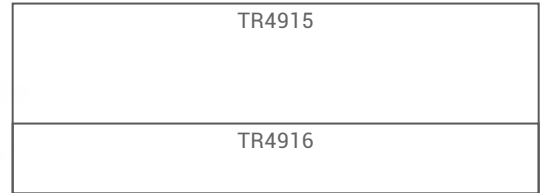
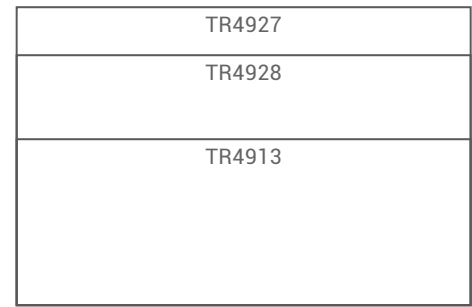
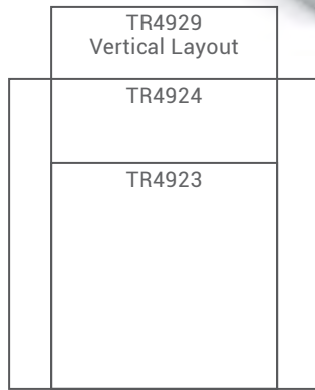

Trodat Printy Self-Inking Stamps

Item #	Impression Area	Max. # of Lines	Replacement Pad
TR46019	3/4" Diameter	3	46019P
TR46140	1 5/8" Diameter	5	46040P
TR46145	1 3/4" Diameter	5	46045P
TR4642	1 5/8" Diameter	8	4642P
TR4910	3/8" x 1"	1	4910P
TR4911	9/16" x 1 1/2"	3	4911P
TR4912	3/4" x 1 7/8"	3	4912P
TR4913	7/8" x 2 3/8"	4	4913P
TR4914	1" x 2 1/2"	5	4914P
TR4915	1" x 2 3/4"	6	4915P
TR4916	3/8" x 2 3/4"	2	4916P
TR4917	3/8" x 2"	2	4817P
TR4918	5/8" x 3"	4	4918P
TR4923	1 3/16" x 1 3/16"	8	4923P
TR4924	1 5/8" x 1 5/8"	8	4924P
TR4925	1" x 3 1/4"	6	4925P
TR4926	1 1/2" x 3"	10	4926P
TR4927	1 9/16" x 2 3/8"	10	4927P
TR4928	1 5/16" x 2 3/8"	8	4928P
TR4929	2" x 1 3/16"	12	4929P



Trodat Typomatic Do It Yourself Stamp Kit

Easily make the stamp yourself!
Offers a high degree of flexibility for your text.



Includes the following
(1) Trodat 4912 Typomatic Stamp, (1) Tweezer,
(2) Type sets with letters, numbers, symbols, and common punctuation

Item #	Impression Area	Max. # of Lines	Replacement Pad
TYPO4912	3/4" x 1 7/8"	4	4912P

Trodat Professional Self-Inking Stamps

- Built for serious use and repetitive stamping.
- The solid metal construction made from brushed stainless steel guarantees greatest possible stability & durability.
- The new finger guard keeps fingers clean when changing the ink cartridge.
- The special grip zones on the feet, combined with the slim stamp design, makes stamping faster and more precise than the competition.
- Outstanding impression quality.
- Eco-friendly - most sizes are Climate Neutral.

Available Ink Colors

- Black
- Red
- Blue
- Dry

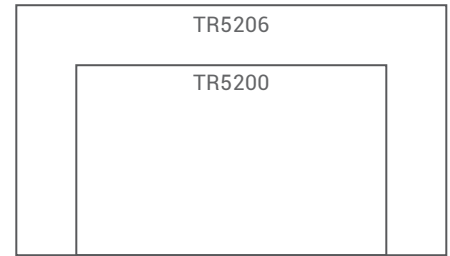
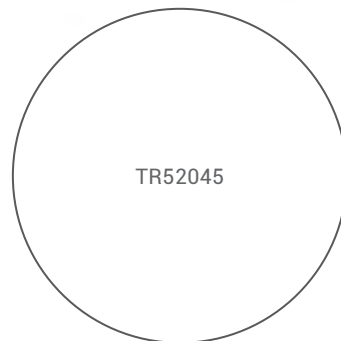

Trodat Professional Self-Inking Stamps

Item #	Impression Area	Max. # of Lines	Replacement Pad
TR5200	1" x 1 5/8"	5	50P
TR5203	1 1/8" x 2"	6	53P
TR5204	1" x 2 3/8"	5	56P
TR5205	1" x 2 3/4"	4	55P
TR5206	1 5/16" x 2 1/4"	6	56P
TR5208	1 13/16" x 2 5/8"	8	58P
TR5211	2 3/16" x 3 3/8"	11	511P
TR52045	1 3/4" Diameter	5	15P

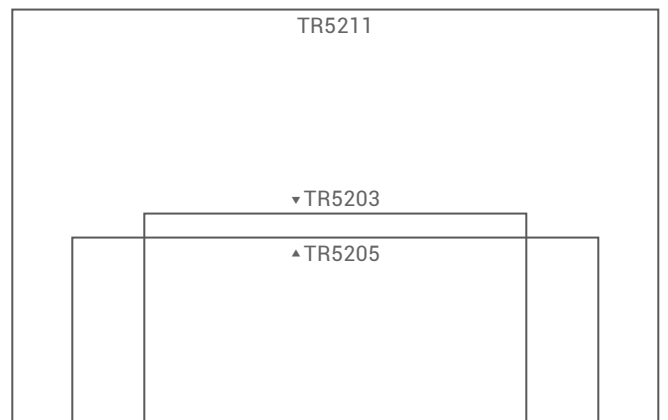

Rubber Stamps

- Traditional and economical stamp option
- Separate stamp pad required to ink
- Available in a variety of sizes
- Perfect for special ink needs

Available Colors

- Black
- Red
- Blue
- Green
- Purple
- Brown

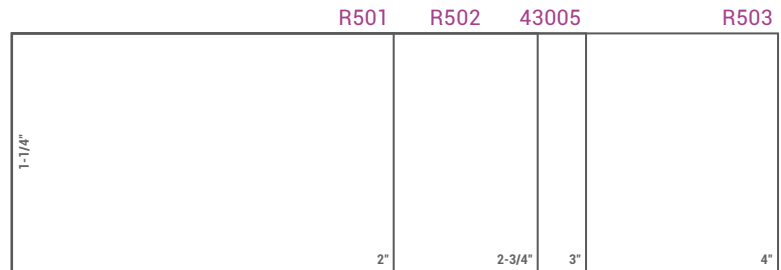
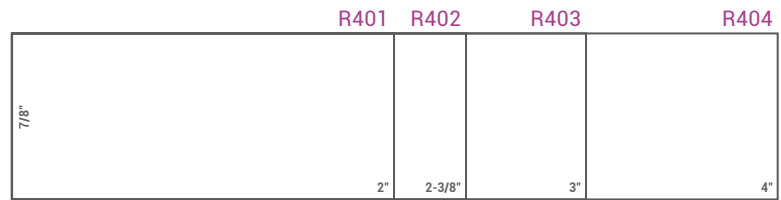
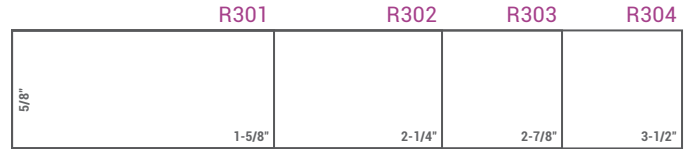
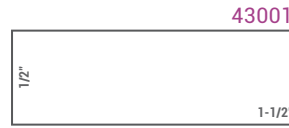
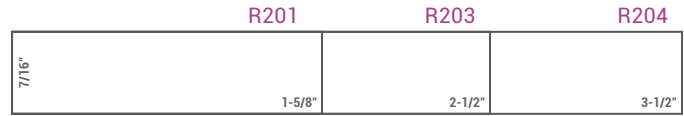

Rubber Stamps

Item #	Impression Area	Max. # of Lines
R101	3/16" x 1 3/8"	1
R102	3/16" x 1 7/8"	1
R103	3/16" x 3 1/2"	1
R201	7/16" x 1 5/8"	3
R203	7/16" x 2 1/2"	3
R204	7/16" x 3 1/2"	3
43001	1/2" x 1 1/2"	3
R301	5/8" x 1 5/8"	4
R302	5/8" x 2 1/4"	4
R303	5/8" x 2 7/8"	4
R304	5/8" x 3 1/2"	4
43002	3/4" x 2"	4
43003	3/4" x 2 1/2"	4
R401	7/8" x 2"	6
R402	7/8" x 2 3/8"	6
R403	7/8" x 3"	6
R404	7/8" x 4"	6
43004	1" x 2 1/2"	6
R501	1 1/4" x 2"	8
R502	1 1/4" x 2 3/4"	8
43005	1 1/4" x 3"	8
R503	1 1/4" x 4"	8
R601	1 5/8" x 2"	10
R602	1 5/8" x 3"	10
R603	1 5/8" x 4"	10
43006	2" x 2"	12
R702	2" x 3"	12
43007	2" x 4"	12
R801	2 1/2" x 2 3/8"	16
R802	2 1/2" x 3 1/4"	16
R803	2 1/2" x 4"	16
43012	3" x 4"	18
43013	3 1/2" x 5"	21
R903	4" x 6"	22
R904	4 1/2" x 7"	26
43017	7/16" Diameter	3
43018	3/4" Diameter	4

43006

R702

43007

43099 | Signature Stamp

Lauren Meyer

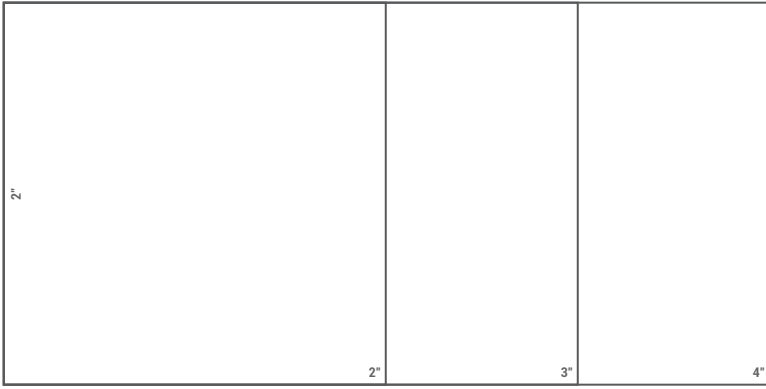

R801

R802

R803

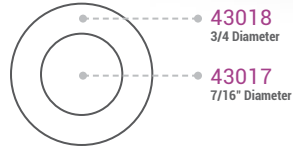
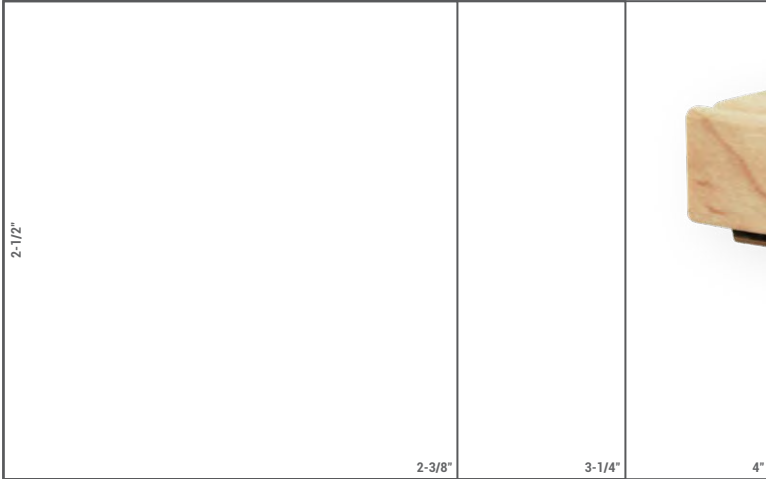

RM904

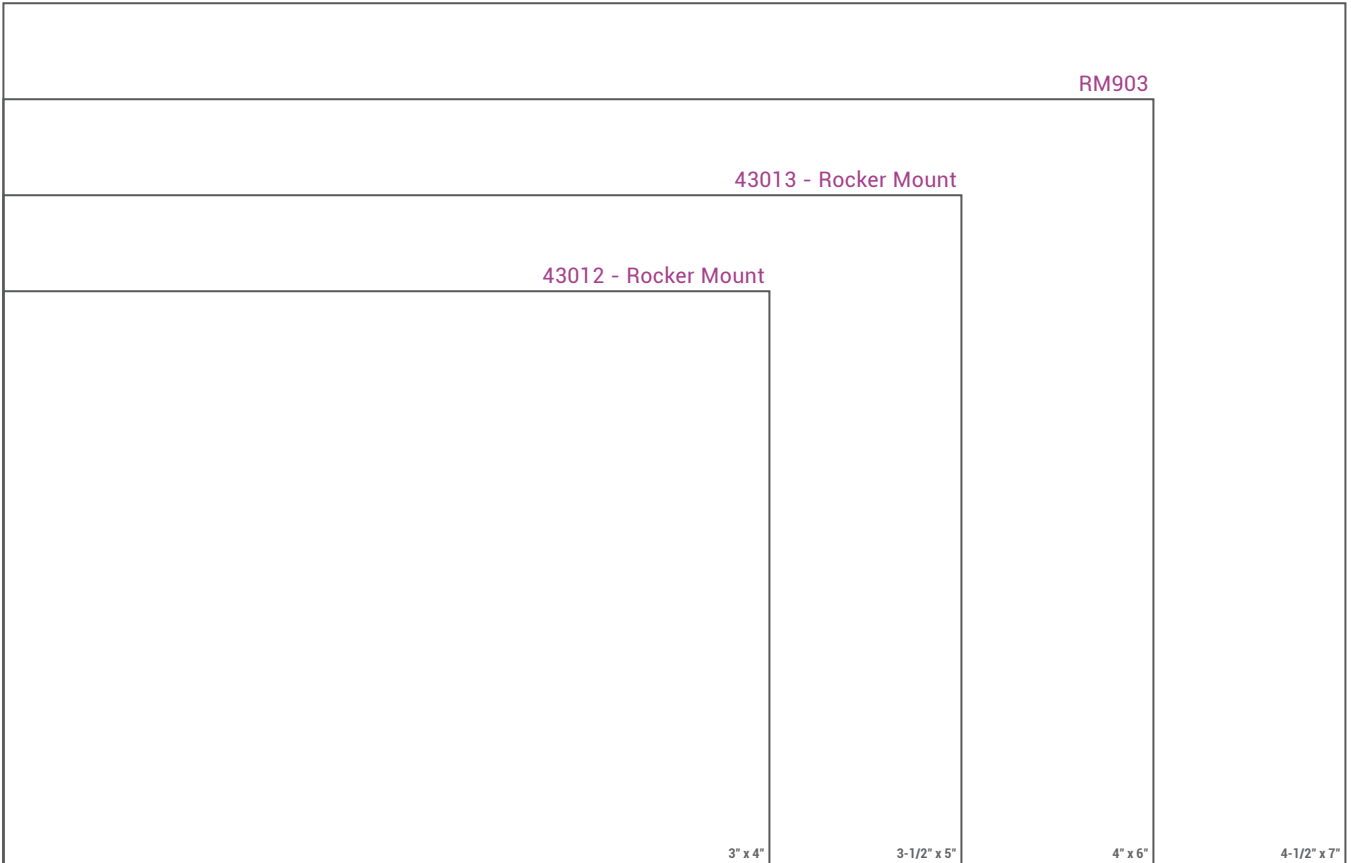

ExcelMark Date Stamps

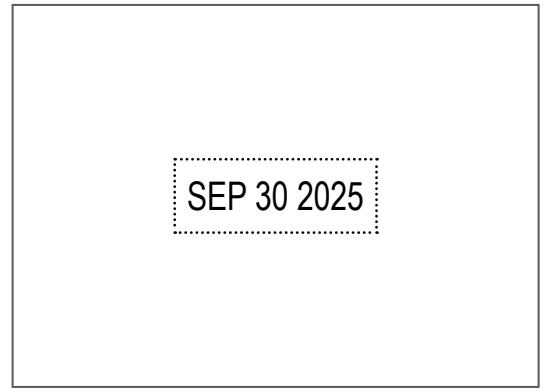

422860 | R800



422660 | R600



422360 | R300



422160 | R100

Custom ExcelMark Self-Inking Date Stamps

Item #	Description	Impression Area	Max. # of Lines	Replacement Pad
422160	1-Color	1" x 1 5/8"	4	462160
422160-2	2-Color	1" x 1 5/8"	4	462160-2
422360	1-Color	1 1/4" x 1 13/16"	6	462360
422360-2	2-Color	1 1/4" x 1 13/16"	6	462360-2
422660	1-Color	1 1/2" x 2 5/16"	6	462660
422660-2	2-Color	1 1/2" x 2 5/16"	6	462660-2
422860	1-Color	2" x 2 3/4"	8	462860
422860-2	2-Color	2" x 2 3/4"	8	462860-2

ExcelMark Stock Message Date Stamps

- Available in two-color impressions.
- Impression Area: 1⁵/₁₆" x 1¹¹/₁₆"
- Replacement Pad: 46R100-2
- MSRP: \$28.95

Stock Dater Colors

Date Color: ● Blue

Message Color: ● Red



Actual
Impression
Size

2160E



2160S



2160EM



2160P



2160R



2160F



Self-Inking Daters

- Includes 6 years of date bands
- Thousands of impressions before re-inking is necessary
- Designed for medium to heavy-duty use

Date & Custom Message Colors

● Black ● Red ● Blue

● Green ● Purple ● Brown

Trodat Dater / Stock Message Series



TR4817

CHECKED AUG 28 2029

↑ Prints the date plus 12 Stock Messages ↑

Includes the following phrases:

- | | | |
|----------------|--------------|---------------|
| 1. ANSWERED | 5. CHARGED | 9. SHIPPED |
| 2. RECEIVED | 6. PAID | 10. BILLED |
| 3. ENTERED | 7. CANCELLED | 11. DELIVERED |
| 4. Backordered | 8. CHECKED | 12. FAXED |



DEC 14 2029

TR4800



PAID AUG 28 2029

TR4813



DEC 14 2029

TR4820



RECEIVED
AUG 28 2029

TR4850

Trodat Printy Self-Inking Dater / Stock Message Series

Item #	Description	Impression Area	Max. # of Lines	Replacement Pad
TR4800	1-Color	1/8" Letter Height		4911P
TR4813	1-Color	3/8" x 1"	1	4817P
TR4817	Dial-A-Phrase / 1-Color	3/8" x 2"		4817P
TR4820	1-Color	3/8" x 1 1/4"		4911P
TR4850	2-Color	3/4" x 1"		4850P



Trodat Professional Daters

- Features impressions in a variety of types and sizes, and covers a wide range of applications.
- Durable stainless steel body.
- Come with 10 years of bands.
- All items are Climate Neutral.



Available Ink Colors

- Black
- Red
- Blue
- Red & Blue



Includes the following phrases:

- | | |
|----------------|--------------|
| 1. ANSWERED | 7. CHECKED |
| 2. Backordered | 8. DELIVERED |
| 3. CANCELLED | 9. ENTERED |
| 4. BILLED | 10. PAID |
| 5. RECEIVED | 11. SHIPPED |
| 6. CHARGED | 12. FAXED |

Trodat Professional Self-Inking Dater

Item #	Description	Impression Area	Max. # of Lines	Replacement Pad
TR5030	1-Color / 10 Year Band	1 5/8" x 3/8"	Prints Date Only	50P
TR5117	Dial-A-Phrase / 1-Color / 10 Year Band	2 1/4" x 3/8"	Prints Message + Date	56P
TR5430	2-Color / 10 Year Band	1" x 1 5/8"	4	50P
TR5440	2-Color / 10 Year Band	1 1/8" x 2"	4	53P
TR5460	2-Color / 10 Year Band	1 5/16" x 2 1/4"	6	56P
TR5474	2-Color / 10 Year Band	1 9/16" x 2 3/8"	6	58P
TR5480	2-Color / 10 Year Band	2" x 2 3/4"	8	58P



Trodat Printy Line & Round Daters

- Small and lightweight.
- Easy to change ink cartridges.
- Many are Climate Neutral.
- Come with 10 years of bands.



Available Ink Colors

- Black
- Red
- Blue
- Red & Blue

Trodat Printy Self-Inking Daters

Item #	Description	Impression Area	Max. # of Lines	Replacement Pad	MSRP
TR43132	2-Color	1 ¼" x 1 ¼"	6	43032-2	\$48.95
TR46130	2-Color	1 ¾" Diameter	6	46030-2	\$52.95
TR46140	2-Color	1 5/8" Diameter	6	46040-2	\$73.95
TR46145	2-Color	1 ¾" Diameter	8	46045-2	\$78.95
TR4724	2-Color	1 5/8" x 1 5/8"	6	4924-2	\$64.95
TR4726	2-Color	1 ½" x 3"	6	4926-2	\$70.95
TR4727	2-Color	1 9/16" x 2 3/8"	8	4927-2	\$73.95
TR4729	2-Color	1 3/16" x 2"	6	4929-2	\$62.95
TR4750	2-Color	1" x 1 5/8"	4	4750-2	\$56.95

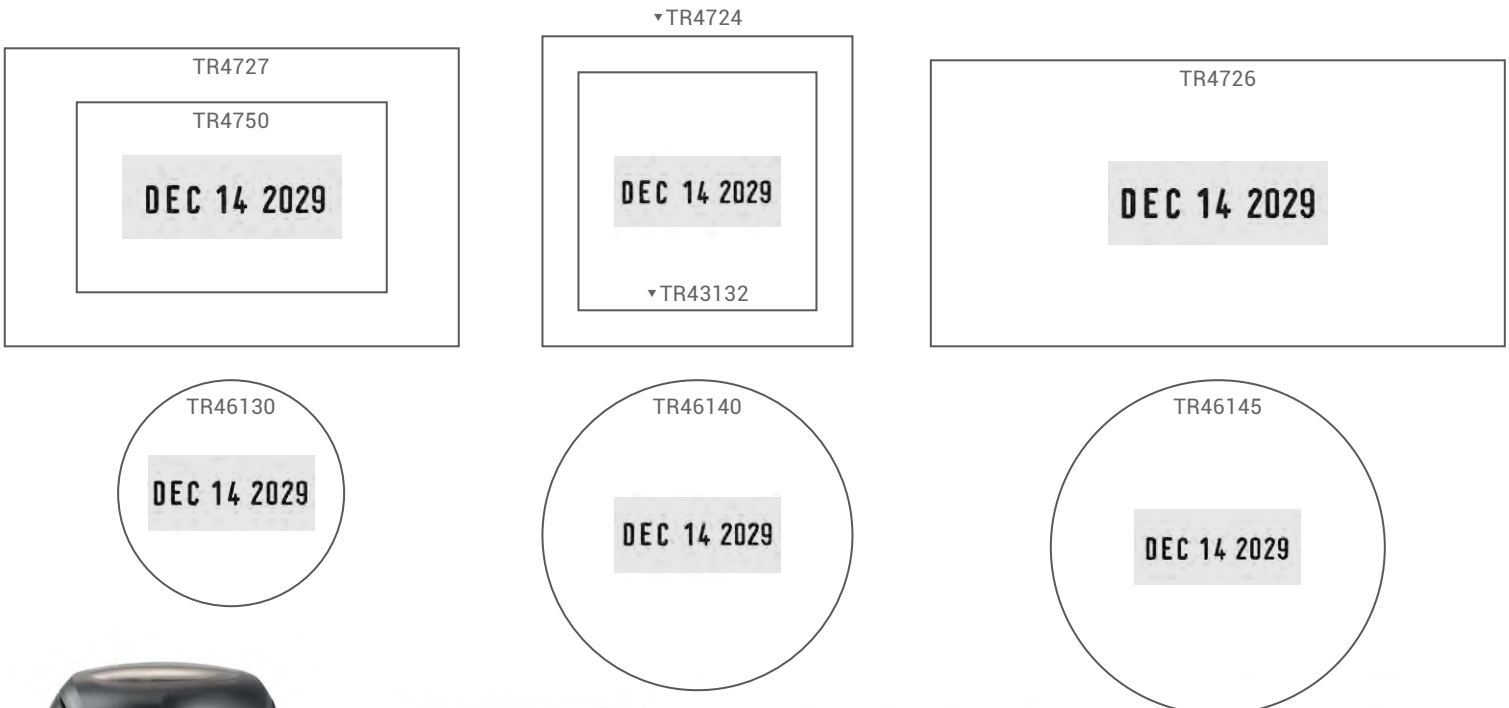



22402
Only available
in the colors
shown



22402
Only available
in the colors
shown

Stock Xstamper XpeDaters

Stock Xstamper XpeDaters

Item #	Impression Area	Max. # of Lines
22402	1 3/4" Diameter	1 Top, 1 Bottom
22602	1 3/4" Diameter	1 Top, 1 Bottom



Stock Xstamper VersaDaters

- 8-year pre-inked line dater.
- Prints stock message plus the month, day, and year. Cannot be customized.
- Date prints in Red, Message prints in Blue.
- The date is easily changed with a quick turn of the dial.
- When you snap on the pre-inked Impression Frame™, you create a whole new message dater.

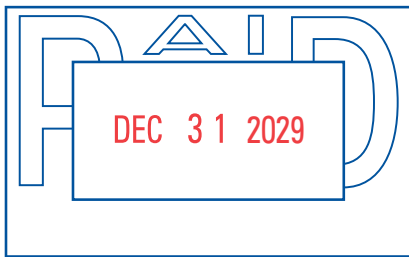

66210

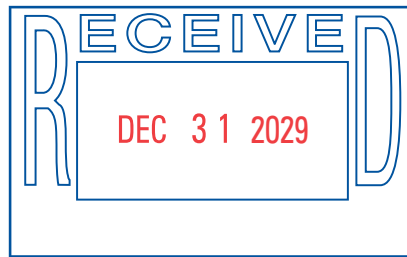

66211

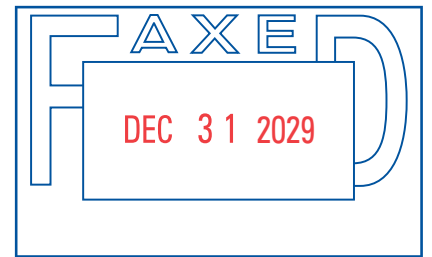

66213



66410
Frame Only



66211
Frame Only



66213
Frame Only

Stock Xstamper VersaDaters

Item #	Message	Impression Area
66210	PAID	1 3/16" x 1 15/16"
66211	RECEIVED	1 3/16" x 1 15/16"
66213	FAXED	1 3/16" x 1 15/16"

Stock VersaDater Message Frames

Item #	Description
66410	PAID Frame ONLY
66411	RECEIVED Frame ONLY
66413	FAXED Frame ONLY

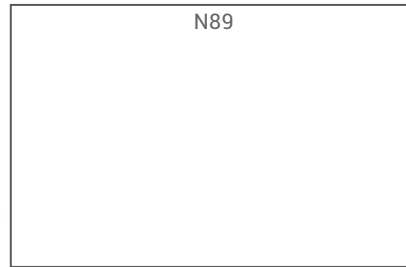
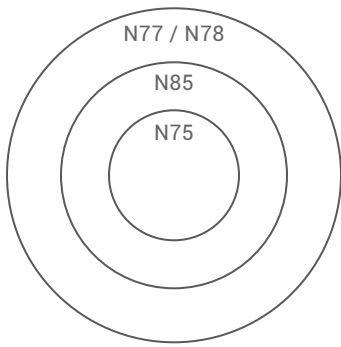

Xstamper XpeDater Date Stamps

- Prints your custom message along with the day, month, and year over a 6-year period.
- A simple twist of the base and a turn of the dials changes the date.

XpeDater Date Stamps

Item #	Impression Area	Max. # of Lines	MSRP
N75	1 ¹ / ₁₆ " Diameter	2	\$68.09
N77	1 ³ / ₄ " Diameter	4	\$100.75
N78	1 ³ / ₄ " Diameter	4	\$100.75
N85	1 ³ / ₁₆ " Diameter	4	\$92.35
N89	1 ³ / ₈ " x 2 ¹ / ₈ "	8	\$88.79

Xstamper VersaDater Pre-Inked Date Stamps

- 8-year pre-inked line dater.
- The date is easily changed with a quick turn of the dial.
- When you snap on the pre-inked Impression Frame™, you create a whole new message dater.

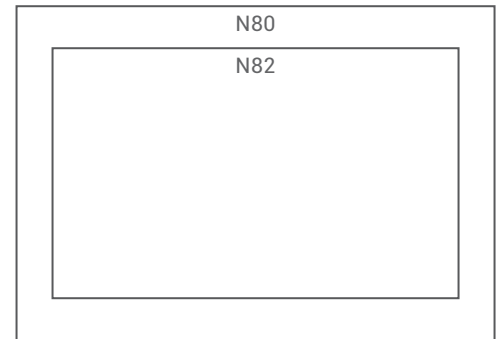

VersaDater Pre-Inked Date Stamps

Item #	Impression Area	Max. # of Lines	MSRP
N80	1 ³ / ₄ " x 2 ¹ / ₂ "	8	\$106.69
N82	1 ⁵ / ₁₆ " x 2 ¹ / ₈ "	4	\$95.09

VersaDater Message Frames

Item #	Description	MSRP
N81	Base ONLY for N80	\$60.49
N83	Base ONLY for N82	\$54.39

Xstamper Date Stamps

- Heavy duty 10-year date stamp is designed for repetitive impressions.
- Comes with its own 2-color pre-inked base.
- 11 ink colors to select from.



Xstamper Date Stamps

Item #	Impression Area	Max. # of Lines	Replacement Base
N90	1 ³ / ₁₆ " x 1 ¹⁵ / ₁₆ "	2 Top, 2 Bottom	66400



Xstamper Line Daters

- Xstamper VersaDater without the impression frame.
- Prints the month, date, and year.
- This stamp is NOT compatible with the impression frame.

Style		Red	Black	Blue
	Small Type	51111	51112	51113
	Large Type	52111	52112	52113
	Julian Type Format	52211	52212	n/a

Xstamper Stamp Trays

- Help keep your stamps organized with the Xstamper Tray Holders.
- Keeps your desk clutter free and all of your stamps together on your desktop or easily tuck away in a drawer.



Item #	Size	Description
07515	7½" x 2½" x 2⅞"	Holds 7 uncapped 1 or 2 Color Stock Stamps (N10), or 12 Stock Specialty Stamps (N32)
07516	9" x 3⅝" x 3"	Holds 5 uncapped Jumbo Stock Stamps (N18)

Trodat Classic Line Dater

- A time-tested solution for marking dates and text on paper.
- This stamp offers durability and virtually no maintenance.
- Requires a separate ink pad.

Trodat Classic Line Dater

Item #	Character Height
TR1000DA-1	No. 0 - 1/8"
TR1010DA	No. 1 1/2 - 5/32"
TR1020	No. 2 - 3/16"

NOV 17 2029

TR1000



NOV 17 2026

TR1010



NOV 17 2026

TR1020



Trodat Die Plate Daters and Numberers

JAN 02 2029

TR1113/3170

JAN 02 2029

TR1113/3150

JAN 02 2029

TR1113/3130

JAN 02 2029

TR1113/3110



TR1117

PAID JAN 02 2029



Includes the following phrases:

- | | | |
|----------------|--------------|--------------|
| 1. ANSWERED | 5. CHARGED | 9. PAID |
| 2. BACKORDERED | 6. CHECKED | 10. RECEIVED |
| 3. CANCELLED | 7. DELIVERED | 11. SHIPPED |
| 4. BILLED | 8. ENTERED | 12. FAXED |

Trodat Die Plate Daters and Numberers

Item #	Maximum Impression Area
TR3170	5/32" Letter Height
TR3110	5/16" x 3/8"
TR3130	5/16" x 3/4"
TR3150	5/16" x 1"
TR3170	5/16" x 1 1/2"

Trodat Classic Dater

- Includes 10 years of date bands.
- Requires a separate ink pad.

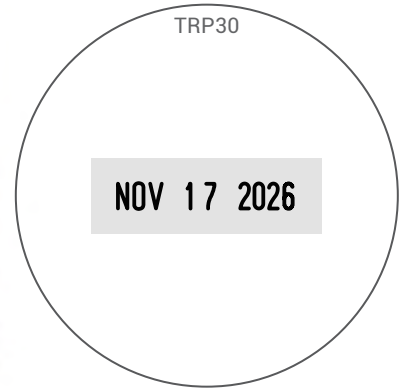

Trodat 2910 Series Classic Dater

Item #	Impression Area	Max. # of Lines
TRP01	1 ³ / ₁₆ " x 2"	6
TRP30	2" Diameter	8

Trodat 3000 Series Classic Die Plate Dater

- Designed for easy application and continuous performance.

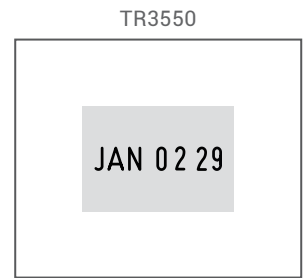
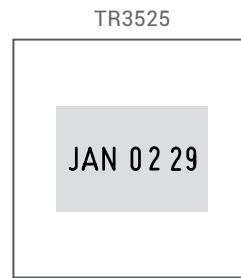
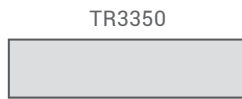

Trodat 3000 Series Classic Die Plate Dater

Item #	Impression Area
TR3350	5/16" x 1 1/4" Single Bridge
TR3450	5/16" x 1 1/4" Double Bridge
TR3525	1 1/4" x 1 1/4"
TR3550	1 1/4" x 1 1/2"

Trodat 4000 Series Classic Die Plate Dater

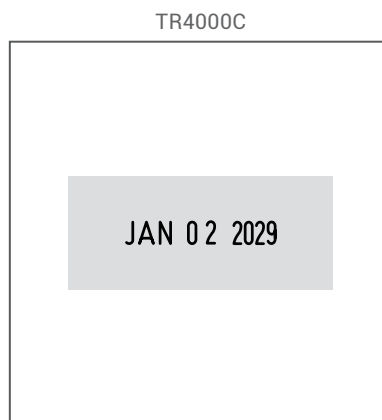
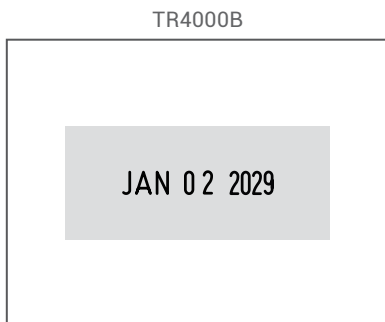

- The 3000 and 4000 Series require a separate ink pad.

Trodat 4000 Series Classic Die Plate Dater

Item #	Impression Area
4000B	1 1/2" x 2"
4000C	2" x 3"

Trodat Classic Numberer

- A time-tested solution for marking dates and text on paper.
- This stamp offers durability and virtually no maintenance.
- Requires a separate ink pad.



1 2 3 4 5 6 7 8 9 0
Size 0 - 1/8" Character Height

1 2 3 4 5 6 7 8 9 0
Size 1 - 1/16" Character Height

1 2 3 4 5 6 7 8 9 0
Size 2 - 3/16" Character Height

1 2 3 4 5 6 7 8 9 0
Size 2.5 - 1/8" Character Height

1 2 3 4 5 6 7 8 9 0
Size 3 - 3/8" Character Height

1 2 3 4 5 6 7 8 9 0
Size 4 - 1/2" Character Height

1 2 3 4 5 6 7 8 9 0
Size 5 - 5/8" Character Height

1 2 3 4 5 6 7 8 9 0
Size 6 - 3/4" Character Height

Bands	4	6	8	10	12
Item #	TR1534	TR1536	TR1538	TR15310	TR15312

Bands	4	6	8	10	12
Item #	TR1544	TR1546	TR1548	TR15410	TR15412

Bands	4	6	8	10	12
Item #	TR1554	TR1556	TR1558	TR15510	TR15512

Bands	4	6	8
Item #	TR1574	TR1576	TR1578

Bands	4	6	8	10	12
Item #	TR1594	TR1596	TR1598	TR15910	TR15912

Bands	6	8
Item #	TR15126	TR15128

Bands	6	8
Item #	TR15156	TR15158

Bands	4	6
Item #	TR15184	TR15186

Trodat Professional Self-Inking Numbering Stamps



- Built for serious use and repetitive stamping.
- The solid metal construction made from brushed stainless steel guarantees greatest possible stability & durability.
- Features a new finger guard that helps you avoid contact with ink, so your fingers stay clean.
- Available in 6, 8, or 10 bands, with or without text plate (PL).

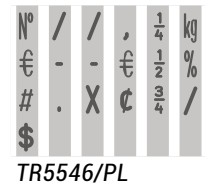
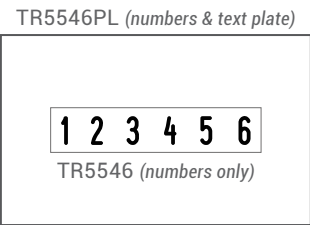

Available Ink Colors

- Black
- Red
- Blue
- Red & Blue

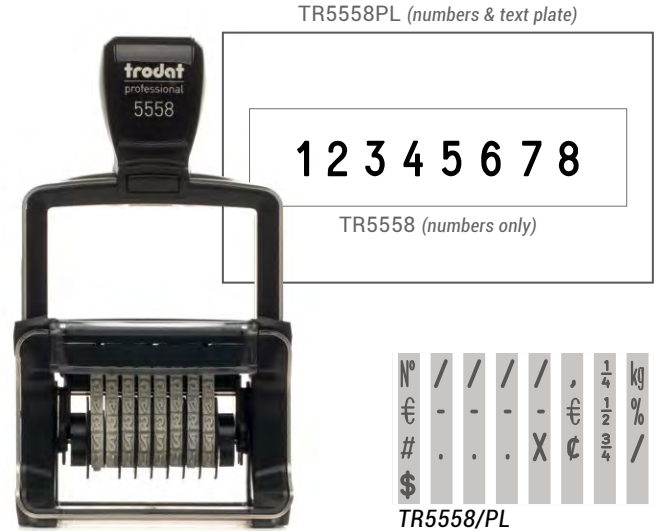

Trodat Professional Self-Inking Numbering Stamps

Item #	Impression Area	Character Height	Number of Bands	Replacement Pad
TR5546	n/a	5/32" Character	6	50P
TR5546PL	1" x 1 5/8"	5/32" Character	6	50P
TR5558	n/a	3/16" Character	8	56P
TR5558PL	1 5/16" x 2 1/4"	3/16" Character	8	56P
TR55510	n/a	3/16" Character	10	56P
TR55510PL	1 5/16" x 2 1/4"	3/16" Character	10	56P

Trodat Printy Numberers

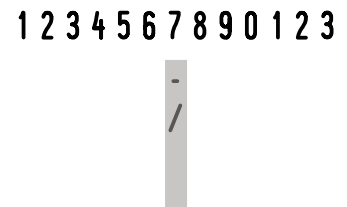
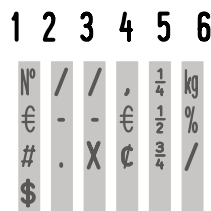
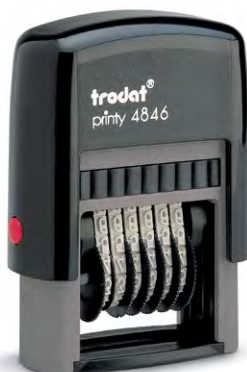

Trodat Printy Numberers

Item #	Replacement Pad	Character Size
TR4846	4911P	No. 1, 5/32"
TR48313	TR4817	No. 0, 1/8"

Automatic Numbering Machines

- Automatically re-inked by self-contained die
- Re-ink with numbering machine ink only

Available Colors

● Black ● Red ● Blue

Rubber Line Daters

Item #	# of Wheels	# of Movements
42740	6	Repeat, 1x, 2x, 3x, 4x, 6x, and 12x
42741	6	Repeat, 1x, 2x, 3x, and 4x
42742	7	Repeat, 1x, 2x, and 3x,
42743	6	Repeat, 1x, 2x, 3x, and 4x
42744	7	Repeat, 1x, 2x, 3x, and 4x

****Numberers, Alphabet Stamps, and Cost/Selling Stamps are available in various sizes upon request.****

Standard Numbering Machine

Ideal for normal everyday use

42741

394725

42742

1574842



Econo Numbering Machine

Ideal for light-duty application

42740

568226



Deluxe Numbering Machine

Ideal for a heavy-duty use

42743

296505

42744

4728852



Please contact Customer Service for pricing questions or additional assistance.

STOCK STAMPS

- Available in your choice of Pre-Inked or Self-Inking stamp style.
- All messages are available in Spanish.
- Impressions area: 1/2" x 1 1/2"



Pre-Inked: FLS54
Self-Inking: SS54



Available Colors
● Red ● Blue

SCANNED

Pre-Inked: FLS12
Self-Inking: SS12

SECOND REQUEST

Pre-Inked: FLS26
Self-Inking: SS26

SHRED

Pre-Inked: FLS49
Self-Inking: SS49

SIGN HERE ⇨

Pre-Inked: FLS18
Self-Inking: SS18

COPY

Pre-Inked: FLS30
Self-Inking: SS30

DEPOSITED

Pre-Inked: FLS40
Self-Inking: SS40

FOR DEPOSIT ONLY

Pre-Inked: FLS50
Self-Inking: SS50

PAYMENT DUE UPON RECEIPT

Pre-Inked: FLS1
Self-Inking: SS1

Thank You!

Pre-Inked: FLS13
Self-Inking: SS13

CONFIDENTIAL

Pre-Inked: FLS97
Self-Inking: SS97

DRAFT

Pre-Inked: FLS98
Self-Inking: SS98

FYI

Pre-Inked: FLS48
Self-Inking: SS48

Please Sign & Return

Pre-Inked: FLS42
Self-Inking: SS42

URGENT

Pre-Inked: FLS43
Self-Inking: SS43

CUSTOMER COPY

Pre-Inked: FLS95
Self-Inking: SS95

DUPLICATE

Pre-Inked: FLS21
Self-Inking: SS21

MAILED

Pre-Inked: FLS20
Self-Inking: SS20

PERSONAL AND CONFIDENTIAL

Pre-Inked: FLS82
Self-Inking: SS82

VOID

Pre-Inked: FLS27
Self-Inking: SS27

COMPLETED

Pre-Inked: FLS80
Self-Inking: SS80

EMAILED

Pre-Inked: FLS102S
Self-Inking: SS102

MOBILE DEPOSIT

Pre-Inked: FLS37
Self-Inking: SS37

POSTED

Pre-Inked: FLS25
Self-Inking: SS25

CANCELLED

Pre-Inked: FLS41
Self-Inking: SS41

CLIENT'S COPY

Pre-Inked: FLS39
Self-Inking: SS39

ENTERED

Pre-Inked: FLS6
Self-Inking: SS6

ORIGINAL

Pre-Inked: FLS59
Self-Inking: SS59

RECEIVED

Pre-Inked: FLS4
Self-Inking: SS4

REVISED

Pre-Inked: FLS22
Self-Inking: SS11

RUSH!

Pre-Inked: FLS10
Self-Inking: SS10

FAXED

Pre-Inked: FLS3S
Self-Inking: SS3

PAID

Pre-Inked: FLS2
Self-Inking: SS2

Past Due

Pre-Inked: FLS15
Self-Inking: SS15

FILE COPY

Pre-Inked: FLS32
Self-Inking: SS32

MINI STOCK STAMP

- Available in Pre-Inked Stamp Style.
- Impression area: 1/2" diameter

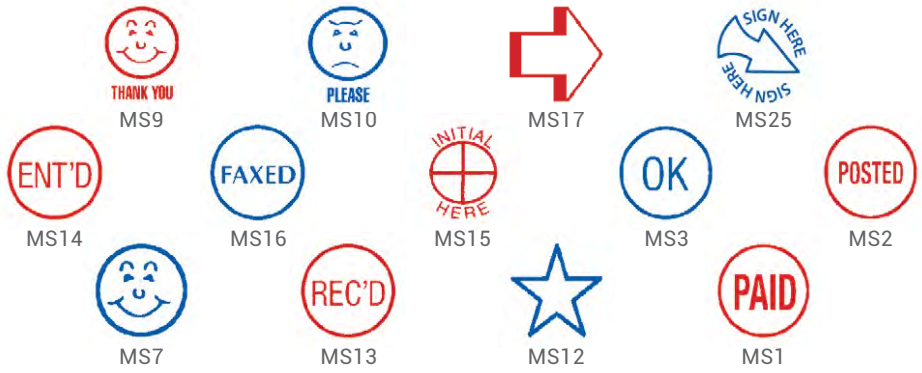

Available Colors

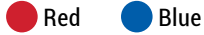

42512 | S-304

APPROVED
MSRP: \$12.15

E-MAILED
FAXED
FILED
PAID
PAST DUE
SCANNED

APPROVED
CANCELLED
CONFIDENTIAL
CONFIRMATION
COPY
FILE COPY

42518 | S-414

APPROVED
MSRP: \$13.50

AIR MAIL
APPROVED
CANCELLED
CONFIDENTIAL
CONFIRMATION
COPY

CHECKED
FILE COPY
FIRST CLASS
CREDIT
OVERDUE
URGENT!



PLASTIC STOCK MESSAGE STAMP

- Available in Self-Inking Stamp Style.
- Includes 12 stock message in two sizes.

Available Colors



IDENTITY THEFT GUARD STAMPS

- Effectively used to hide confidential information to help prevent identity theft.

Rolling Identity Theft Guard Stamp

- Part # ID-ROLLER
- Impression Area: 1 1/2" x up to 100 meters in length.
- To use, simply open the cover and start swiping.
- Re-inkable for unlimited use.
- Re-inkable with ExcelMark Flash Ink (2cc Only).



Identity Theft Guard Stamp

- Part # 42020-SEC
- Dimensions: 9/16" x 1 1/2"



Stamp Pattern

- Self-Inking stamp designed with a special pattern to hide confidential information printed beneath.
- Ideal for use on junk mail, or anything containing personal information.



NOTARY STAMPS & EMBOSSERS

Notary stamps and embossers meet the strict requirements of each state, and are available in a variety of sizes.



42098



51102



FL2773



43098



Embosser

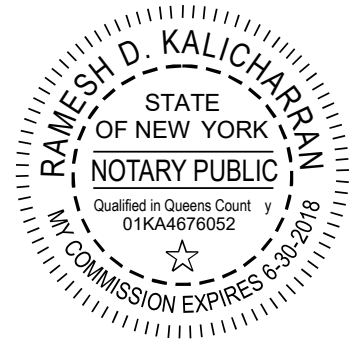
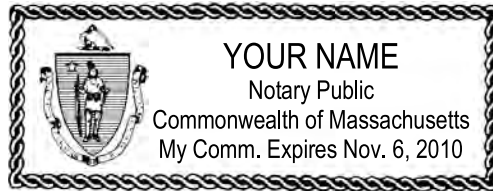

Requirements by State

Each state has its own requirements for notary stamps and seals. Some states require a notary certificate or additional steps may be required in order to produce your item.

Item #	Description
51102	Pre-Inked Notary Stamp with Rectangle Imprint
51102-C	Pre-Inked Notary Stamp with Circle Imprint
42098	Self-Inking Notary Stamp with Rectangle Imprint
42098-C	Self-Inking Notary Stamp with Circle Imprint
43098	Rubber Notary Stamp with Rectangle Imprint
43098-C	Rubber Notary Stamp with Circle Imprint
FL2773	SuperSlim Notary Stamp with Rectangle Imprint
FL2773-C	SuperSlim Notary Stamp with Circle Imprint
EM001	Pocket Embosser - Circle
EM003	Pocket Embosser - Rectangle
ED001	Desk Embosser - Circle
ED003	Desk Embosser - Rectangle

NOTARY SUPPLIES

Choose from a variety of exceptional notary supplies to save time, provide security, and keep accurate records.

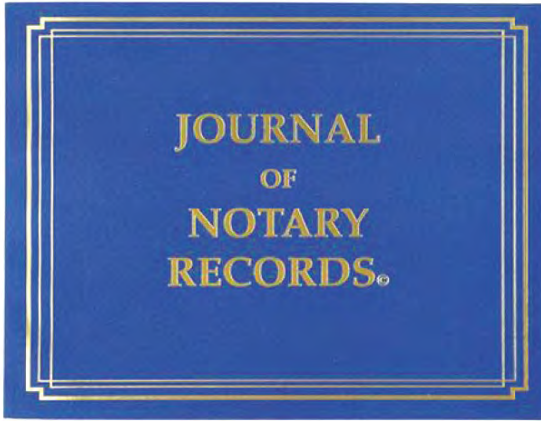

47003

- Journal includes 142 pages to accommodate 639 entries.



43211

- Create a thumbprint without ink, setup, or cleanup. The ink rubs off fingers and won't stain skin. Best of all, it will work on almost any paper.

Item #	Description
47003	Standard Notary Journal
NJ5000	Premium Notary Journal
43211	Inkless Thumbprint Pad

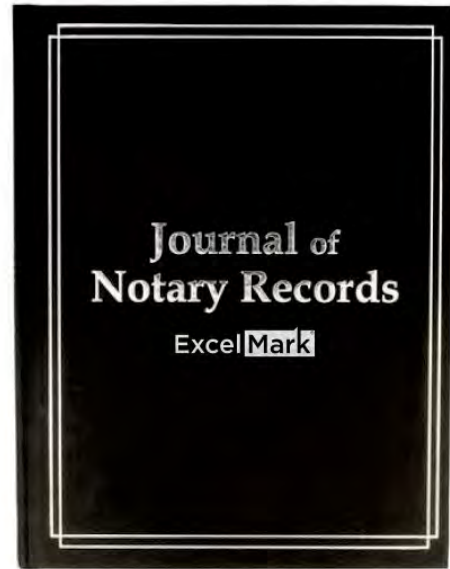

NJ5000

- 100 pages to accommodate 300 entries.
- Includes instructional page for journal entry forms.
- Well-bound hardcover.

NOTARY BONDS AND E&O INSURANCE



Notary Bonds

Notary Bonds are available for every state that requires notaries to purchase a bond for the duration of their commissions. Notary bonds protect the general public against financial loss due to a mistake or an improper or negligent act performed by the notary. Notary bonds offer no insurance protection to the notary.

Errors & Omissions Insurance

Notary E & O Insurance protect the notary against errors or omissions when notarizing that financially harms the public.

Please contact us for more details.

PROFESSIONAL STAMPS

Professional stamps are available in a variety of stamp and embosser styles to meet your specific requirements.

Corporate Seals

Authenticate your company documents with corporate seals from Schwaab, available in a variety of styles.

Engineer and Architect Stamps + Seals

Schwaab has Engineer, Architect and other professional stamp and embosser requirements for all 50 states in a variety of styles.



Item #	Description
51104	Pre-Inked Engineer & Architect Stamp
42097	Self-Inking Engineer & Architect Stamp
43097	Rubber Engineer & Architect Stamp
51196	Pre-Inked Corporate Stamp
42096	Self-Inking Corporate Stamp
43096	Rubber Corporate Stamp

PROFESSIONAL KITS

Corporate Kits allow you to organize and protect all of your important company information.

- Corporate Seal in a pocket embosser with vinyl carrying case.
- Black, vinyl finish 3-ring binder.
- Bound stock transfer ledger or membership rolls where applicable.
- 20 custom imprinted green stock certificates.
- Optional printed minutes & bylaws.
- 20 matching stub sheets.



Plain Corporate Kits

Contain (20) Blank Certificates, Company Seal, Blank Minute Book Pages, and a Transfer Ledger - all in a 3-Ring Binder with Slip Case

Standard Kits

as above, but with Custom Imprinted Certificates

Premium Kits

as above, but with Printed Minutes and Bylaws

Description	Kit with Embosser Item #	Kit with Stamp Item #
Plain Corporate Kit	CK-01	CKS-01
Standard Corporate Kit	CK-02	CKS-02
Premium Corporate Kit	CK-03	CKS-03
Plain Non-Profit Corporate Kit	CK-04	CKS-04
Standard Non-Profit Corporate Kit	CK-05	CKS-05
Premium Non-Profit Corporate Kit	CK-06	CKS-06
Plain LLC & PLLC Kit Printed	CK-07	CKS-07
Standard LLC & PLLC Kit Printed	CK-08	CKS-08
Premium LLC & PLLC Corporate Kit	CK-09	CKS-09
General Corporation Printed Minutes & Bylaws	CK-10	
LLC Printed Minutes & Bylaws	CK-11	
Non-Profit Printed Minutes & Bylaws	CK-12	
LLC Printed Burgundy Stock Certificates - 25/Set	CK-26	
Printed Stock Certificates	PSC	

HAND HELD EMBOSSESSER

- Perfect for carrying with you and storing in small spaces.
- Includes a vinyl carrying case.

EM001 | EM002 | EM003

Item #	Description	Dimensions
EM001	Pocket Embosser	1 5/8" Diameter
EM002	Pocket Embosser	2" Diameter
EM003	Pocket Embosser	1" x 2"
EM010	Pocket Handle Only	



DESK EMBOSSESSER

- Stationary model.
- Includes a vinyl carrying case.

Item #	Description	Dimensions
ED001	Desk Seal Embosser	1 5/8" Diameter
ED002	Desk Seal Embosser	2" Diameter
ED003	Desk Seal Embosser	1" x 2"
ED010	Desk Handle	

ED001 | ED002 | ED003



HAND HELD + DESK EMBOSSESSER CLIP INSERTS

Item #	Description	Dimensions
EZ001	Excelmark Embosser Clip Insert	1 5/8" Diameter
EZ002	Excelmark Embosser Clip Insert	2" Diameter
EZ003	Excelmark Embosser Clip Insert	1" x 2"



- Replace your existing clip with a new insert when you need to change information, or add an additional clip to make your new embosser more versatile.

EH004 | EH002



LONG REACH EMBOSSESSER

- Designed for heavy duty usage.
- Includes an extra-long handle for 2 1/2" reach.

Item #	Description	Dimensions
44011	Long Reach Desk Embosser	1 3/4" Diameter
44012	Long Reach Desk Embosser	2" Diameter

GIFT EMBOSSESSER

- Premium embosssers that add a touch of elegance.
- Includes a felt base to ensure no slipping during use.
- Excellent gift idea.

44004GG | 44006GG

Item #	Description	Dimensions
44004GG	Gold Gift Embosser	1 5/8" Diameter
44006GG	Gold Gift Embosser	1" x 2"
44004CG	Silver Gift Embosser	1 5/8" Diameter
44006CG	Silver Gift Embosser	1" x 2"



44004CG | 44006CG



49021

SEAL INKER

- Used to make seal impressions suitable for photocopying or faxing.

Available Color

- Black



49020

GOLD FOIL SEALS

- Emboss an image on a gold foil seal to add a touch of class and professionalism to your documents.
- 40 seals per package.

CLASSIC ENGRAVED BADGES

- Engraved plastic name badges with beveled edges to provide a distinctive appearance.
- Please see Page 60 for Plastic Color Choices.

45008



45011



45014



45019



45005

Item #	Size	Max. # of Lines
45180	1/2" x 2"	2
45181	3/4" x 2 3/4"	2
45005	3/4" x 3"	2
45263	1" x 2 1/2"	3
45184	1" x 2 3/4"	3
45008	1" x 3"	3
45182	1 1/4" x 3"	3
45193	1 1/4" x 3 1/4"	3
45011	1 1/2" x 3"	3
45158	1 1/2" x 3 3/4"	3
45019	1 3/4" x 2 1/2" (Oval)	3
45370	1 1/2" x 3 1/2"	3
45014	2" x 3"	4
45357	2" x 3 1/4"	4
45183	2" x 3 1/2"	4
45185	2" x 4"	4



DESIGNER ENGRAVED BADGES

- Engraved plastic name badges applied to a silver or gold carrier to bring a premium appearance to any attire.
- Please see Page 60 for Plastic Color Choices.

Item #	Faceplate Size	Carrier Size	Max.# of Lines
45008D	1 ³ / ₁₆ " x 2 ¹³ / ₁₆ "	1" x 3"	3
45011D	1 ¹ / ₄ " x 2 ³ / ₄ "	1 ¹ / ₂ " x 3"	3
45019D	1 ⁹ / ₁₆ " x 2 ⁷ / ₁₆ " (Oval)	1 ¹¹ / ₁₆ " x 2 ⁹ / ₁₆ " (Oval)	3

Badge Carrier Colors

- Gold
- Silver

45019D



45011D



45008D

FRAMED ENGRAVED BADGES

- Engraved plastic name badge with a gold, silver, or black plastic frame.
- Please see Page 60 for Plastic Color Choices.

Item #	Faceplate Size	Max. # of Lines
FNBE13	1" x 3"	3
FNBE153	1 ¹ / ₂ " x 3"	3
FNBE23	2" x 3"	4

FNBE13



FNBE23



FNBE153



FULL COLOR PLASTIC BADGES

- Dynamic name badges, digitally printed in any colors.
- On your choice of white, silver, or gold plastic.



45115P



45114P



45113P



45116P

Badge Colors



Premium Shapes:
Create your own custom shape
or choose from one of our
stock shapes.



Style 1



Style 2



Style 3



Style 4



Style 5



Style 6



Style 7



Style 8



Style 9



Style 10



45135
Custom Shape

Item #	Size	Max. # of Lin
45113	1" x 3"	3
45190	1" x 3¼"	3
45459	1" x 3½"	3
45262	1¼" x 3"	3
45187	1¼" x 3¼"	3
45189	1¼" x 3½"	3
45271	1½" x 3" (Oval)	3
45114	1½" x 3"	3
45197	1½" x 3¼"	3
45188	1½" x 3½"	3
45116	1¾" x 2½" (Oval)	3
45170	1¾" x 3"	4
45186	1¾" x 3¼"	4
45457	1¾" x 3½" (Oval)	4
45191	1⅝" x 3⅜"	4
45115	2" x 3"	4
45289	2" x 3¼"	4
45458	2" x 3½"	4
45282	2⅛" x 3⅜"	4

49004 One time set up Charge. Call for Pricing.
An art fee will be charged if production ready art is not provided.

FULL COLOR ALUMINUM BADGES

- Vibrant name badges digitally printed in any colors.
- On your choice of white, silver, or gold Aluminum.

Aluminum Badge Colors

● Gold ● Silver ○ White

Item #	Size	Max. # of Lines
45113A	1" x 3"	3
45114A	1½" x 3"	3
45115A	2" x 3"	4
46186A	1¾" x 3¼"	4

An art fee will be charged if production ready art is not provided.

A one time art charge is applied if production ready art is not supplied. Contact us for volume discount pricing.



45115A



45114A



45113A

FRAMED FULL COLOR BADGES

- Digitally printed name badge with a gold, silver, or black plastic frame.
- Name badge insert available in white, silver or gold plastic.

Item #	Faceplate Size	Max. # of Lines
FNBF13	1" x 3"	3
FNBF153	1½" x 3"	3
FNBF23	2" x 3"	4

An art fee will be charged if production ready art is not provided.



Badge Colors

● Gold ● Silver ○ White

DESIGNER FULL COLOR BADGES

- Aesthetically appealing full color badges with metal faceplate and badge carrier.
- Any imprint color is available.

Item #	Faceplate Size	Carrier Size	Max. # of Lines
45008F	1 ³ / ₁₆ " x 2 ¹³ / ₁₆ "	1" x 3"	3
45011F	1" x 3"	1 ¹ / ₄ " x 3 ¹ / ₄ "	3
45019F	1 ⁹ / ₁₆ " x 2 ⁷ / ₁₆ "	2 ¹¹ / ₁₆ " x 1 ¹⁵ / ₁₆ "	4
45098F	1 ⁷ / ₁₆ " x 2 ¹³ / ₁₆ "	1 ⁵ / ₈ " x 3"	3

An art fee will be charged if production ready art is not provided.

Faceplate Colors



Badge Carrier Colors



POCKET BADGES

- Pocket badges are heat folded to slip over a pocket and stay in place.
- Available in engraved or digitally printed.
- Please see Page 60 for Plastic Color Choices.

Item #	Faceplate Size
45140	1 ¹ / ₂ " x 3"

An art fee will be charged if production ready art is not provided.



METAL UNIFORM BADGES

- Laser engraved with black letters and includes a military clutch.

Badge Colors



Item #	Faceplate Size
45550	1/2" x 2 3/8"

An art fee will be charged if production ready art is not provided.

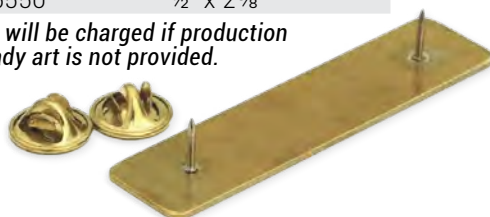

Contact us for volume discount pricing.

REUSABLE MESSAGE BADGES

- Available in chalkboard or dry erase styles!
- Customize with a full color logo or text, or order blank and write in your own customization.
- Lightweight and easy to use.

Chalkboard

Designed for use with standard chalk.



45135 Custom Shape

Item #	Size
45146	1" x 3"
45147	1½" x 3"
45148	2" x 3"
45149	1-5 Square Inches

An art fee will be charged if production ready art is not provided.

*Deduct 40% for blank badges.

Available Colors

- Black
- White
- Pine Green

Dry Erase

Designed for use with standard dry erase markers



45153

Item #	Size
45150	1" x 3"
45151	1½" x 3"
45153	2" x 3"
45154	1-5 Square Inches

An art fee will be charged if production ready art is not provided.

*Deduct 40% for blank badges.

Available Colors

- Black
- White

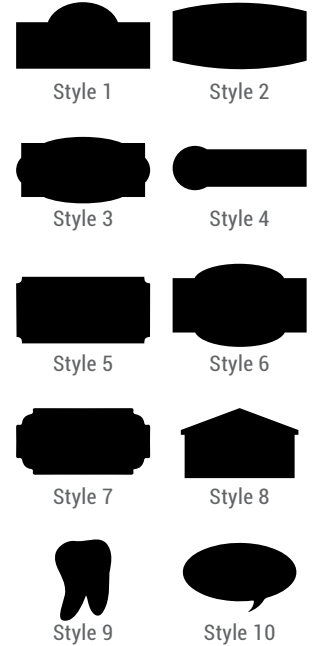

Create your own custom shape or choose from one of our stock shapes.

PHOTO ID BADGES

- Full color badge digitally printed on white plastic and includes a photo.
- Slot punches available on request.

Item #	Faceplate Size
45138	2" x 3"

An art fee will be charged if production ready art is not provided.



BADGE ACCESSORIES

Item #	Description
45101	Pin
45102	Clip
45103	Magnet
45104	Pocket Holder
45142	Plastic Card Holder
45106	Lanyard
45143	Bull Dog Straps
45110	Retractable Badge Reel



Pin



Magnet



Clip



Bull Dog Straps



Plastic Card Holder



Pocket Holder



Lanyard



Retractable Badge Reel

Nameplate Inserts

Step 1: Choose an insert material and imprint preference from the below options.

We make **CUSTOMIZING** your nameplate **EASY!**

CLASSIC ENGRAVED

- Professionally engraved plastic nameplates available in a variety of color combinations.



Insert Colors

Please see Page 60 for Insert Colors.

Item #	Size	MSRP
45194	1" x 8"	\$11.00
45288	1½" x 8"	\$11.75
45286	1" x 10"	\$11.50
45264	1½" x 10"	\$12.25
45366	2" x 6"	\$11.75
45020	2" x 8"	\$12.50
45021	2" x 10"	\$13.50
45265	2" x 12"	\$17.40
45274	3" x 12"	\$22.95

FULL COLOR

- Digitally printed plastic nameplates ideal for logos and graphics.

Item #	Size	MSRP
45291	1" x 8"	\$11.00
45292	1" x 10"	\$11.50
45290	2" x 8"	\$12.50
45293	2" x 10"	\$13.50

An art fee will be charged if production ready art is not provided.



Nameplate Colors

Gold Silver White

BRASS & ALUMINUM

- Engraved aluminum and brass nameplates for a distinctive appearance.
- Choose from engraved or engraved with black oxidization.

Engraved Aluminum with Black Painted Letters



Engraved Brass with Black Oxidation



Engraved Black/Gold Brass



Item #	Description	Size	MSRP
NPAL8	Aluminum	2" x 8"	\$22.50
NPAL10	Aluminum	2" x 10"	\$28.50
NPBR8	Brass	2" x 8"	\$22.50
NPBR10	Brass	2" x 10"	\$28.50
NPBG8	Black/Gold Brass	2" x 8"	\$18.00
NPBG10	Black/Gold Brass	2" x 10"	\$20.00

Wall Fasteners



STICKY TAPE
Item: 45124
Price: NC

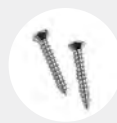

SCREWS (2)
Item: 45125
Price: NC



FOAM TAPE
Item: 45131
Price: \$2.25

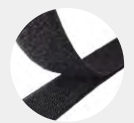

VELCRO
Item: 45120
Price: \$2.25

Nameplate Holders

Step 2: Now choose your optional holder from the many styles shown below.

ALUMINUM WALL HOLDERS

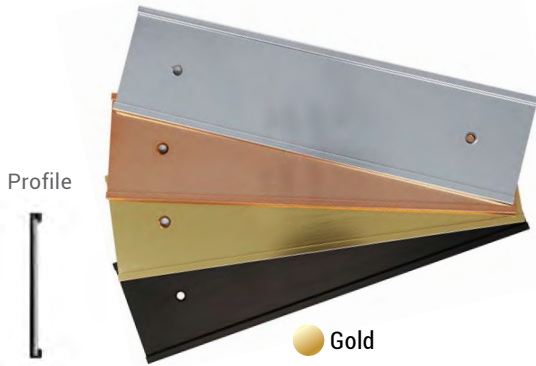

- Accommodates inserts up to 1/16" thick.

Item #	Style	Corner	Size
45211	Wall	Square	1" x 8"
45800	Wall	Square	1 1/2" x 8"
45801	Wall	Square	1" x 10"
45802	Wall	Square	2" x 6"
45036	Wall	Square	2" x 8"
45037	Wall	Square	2" x 10"
45351	Wall	Square	2" x 12"
45353	Wall	Square	3" x 12"

● Gold

● Black

● Rose Gold

● Silver

ALUMINUM DESK HOLDERS

- Accommodates inserts up to 1/16" thick.



Item #	Style	Corner	Size
45210	Desk	Square	1" x 8"
45034	Desk	Square	2" x 8"
45035	Desk	Square	2" x 10"
45803	Desk	Square	2" x 12"

● Gold

● Black

● Rose Gold

● Silver

PLASTIC WALL HOLDERS

- Available with square or 1/2" radius corners.
- Accommodates inserts up to 1/8" thick.



Item #	Style	Corner	Size
PP8S	Wall	Square	2" x 8"
PP8R	Wall	Round	2" x 8"
PP10S	Wall	Square	2" x 10"
PP10R	Wall	Round	2" x 10"

● Almond

● Black

● Brown

● Medium Grey

● Pewter

PLASTIC BASE HOLDERS



Item #	Style	Color	Size
PB8	Base	Clear	2" x 8"
PB8-BLK	Base	Black	2" x 8"
PB10	Base	Clear	2" x 10"
PB10-BLK	Base	Black	2" x 10"

○ Clear

● Black

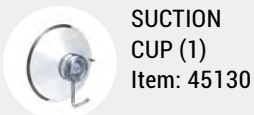

SUCTION CUP (1)
Item: 45130



FABRIC PINS (2)
Item: 45121



MAGNETIC TAPE
Item: 45122

SM PLASTIC HANGER
Item: 45123
3 1/2" L, 2 1/8" D, 1 7/8" H



LG PLASTIC HANGER
Item: 45126
6" L, 3" D, 2 1/4" H

Desk Bars and Designer Wood Nameplates

BLACK PLASTIC DESK BAR

- Engraved plastic inserts can be ordered with a frame or as an insert only.
- Accommodates inserts up to 1/16" thick.
- Holder Color: Black



Item #	Style	Corner	Size
45311	Desk Bar + Plate	Square	1 3/4" x 9 1/8"
45312	Desk Bar Insert Only	Square	1 3/4" x 9 1/8"
45313	Desk Bar + Plate	Round	1 3/4" x 9 1/8"
45314	Desk Bar Insert Only	Round	1 3/4" x 9 1/8"

Designer Desk Wedges

- Designer Desk wedges are available in Piano Finish or Walnut
- Finishing Options: Metal, Engraved Plastic, or Digitally Printed Aluminum Nameplate.

Metal Insert Color Options:

Black Aluminum w/ Gold Letters,
Black Aluminum w/ Silver Letters,
Black Brass w/ Gold Letters,
Brushed Aluminum w/ Black Letters,
Brass Engraved

Plastic Insert Color Options:

Please see Page 60
for Insert Colors.

Aluminum Insert Colors:

Gold, Silver, or White

PIANO FINISH DESK WEDGE



Item #	Insert	Finish	Length	Plate Size
45362	Metal	Rosewood	8 1/2"	2" x 8"
45358	Metal	Rosewood	10 1/2"	2" x 10"
45360	Metal	Piano Black	8 1/2"	2" x 8"
45361	Metal	Piano Black	10 1/2"	2" x 10"
45605	Engraved Plastic	Rosewood	8 1/2"	2" x 8"
45608	Engraved Plastic	Rosewood	10 1/2"	2" x 10"
PFW8S	Engraved Plastic	Piano Black	8 1/2"	2" x 8"
PFW10S	Engraved Plastic	Piano Black	10 1/2"	2" x 10"
45609	Full Color Aluminum	Rosewood	8 1/2"	2" x 8"
45611	Full Color Aluminum	Rosewood	10 1/2"	2" x 10"
45612	Full Color Aluminum	Piano Black	8 1/2"	2" x 8"
45613	Full Color Aluminum	Piano Black	10 1/2"	2" x 10"



WALNUT DESK WEDGE



Item #	Insert	Holder	Length	Plate Size
45332	Metal	Wedge	8 1/2"	2" x 8"
45334	Metal	Wedge	10 1/2"	2" x 10"
45331	Engraved Plastic	Wedge	8 1/2"	2" x 8"
45333	Engraved Plastic	Wedge	10 1/2"	2" x 10"
45614	Full Color Aluminum	Wedge	8 1/2"	2" x 8"
45615	Full Color Aluminum	Wedge	10 1/2"	2" x 10"

Item #	Insert	Holder	Length	Plate Size
45440	Metal	Business Card	10 1/2"	2" x 10"
45700	Engraved Plastic	Business Card	10 1/2"	2" x 10"
45617	Full Color Aluminum	Business Card	10 1/2"	2" x 10"

Designer Acrylic and Glass Desk Nameplates

ACRYLIC NAMEPLATE

- Item: ACBNP
- MSRP: \$39.99
- Size: 2½" x 8" x 1⅛"

Choose from one of our designs or customize your own by adding a company logo, background, or image.



Orchids



Golf Course



Palette



Marble Clear



Black Granite



Leopard



Floral Purple



Zebra Stripes



Gold Granite



Tropical in Navy



Clear



Marble Gold



Golf Ball



Floral Pink



Tiger Stripes



Black and Gold

SANDBLASTED GLASS

- Glass nameplate with sandblasted customization and a modern chrome holder.



Item #	Size	MSRP
45401	3" x 10"	\$62.30

CUSTOM ENGRAVED PLASTIC SIGNAGE



We craft our engraved signs using high-quality, two-ply plastic and laser engrave them with your personalized message.

Features

- Plastic signs are available in wall, tent, or pedestal style.
- Scratch resistant.
- Sizes: Up to 24" x 48"
- Thickness Options:

1/16" 1/8"

Corner Options:

- Square (default)
- Round

Edge Options:

- Straight (default)
- Beveled

Mounting Options:

See Page 39 for available options

Wall Signs:

Mountable to any flat surface, wall signs offer an excellent means to convey messages and offer guidance within a building.

PAYMENT IS REQUIRED WHEN SERVICES ARE RENDERED UNLESS OTHER ARRANGEMENTS ARE MADE IN ADVANCE



Pedestal Signs:

This self-supporting sign is crafted from folded plastic, creating a pedestal at the base, and can be exhibited on any level surface. Ideal for communicating information in an eye-catching manner.

Tent Signs:

This freestanding sign consists of folded plastic, shaped like a tent, and can be displayed on any flat surface. Ideal for conveying information in a compact and easily visible format. Can be engraved on both sides



To determine the MSRP and Item # for your sign, simply follow these steps and refer to this grid.

Wall Sign

- Multiply the Length x Width of your sign face to find the total square inches.



Pedestal Sign

- Multiply the sign face by 1.5 to determine the total square inches.



Tent Sign

- Multiply the sign face by 2 to determine the total square inches.



For 1/8" material and sizes not shown, Please contact us for a quote.

The displayed prices are applicable to 1/16" thick material only.

Square Inches	Engraved Wall Sign	Engraved Tent Sign	Engraved Pedestal Sign
1-5	45380	45380-T	45380-P
6-10	45381	45381-T	45381-P
11-15	45382	45382-T	45382-P
16-20	45383	45383-T	45383-P
21-25	45384	45384-T	45384-P
26-30	45385	45385-T	45385-P
31-35	45386	45386-T	45386-P
36-40	45387	45387-T	45387-P
41-45	45388	45388-T	45388-P
46-50	45389	45389-T	45389-P
51-55	45390	45390-T	45390-P
56-60	45391	45391-T	45391-P
61-65	45392	45392-T	45392-P
66-70	45393	45393-T	45392-P
71-75	45394	45394-T	45394-P
76-80	45395	45395-T	45395-P
81-85	45396	45396-T	45396-P
86-90	45397	45397-T	45397-P
91-95	45398	45398-T	45398-P
96-100	45399	45399-T	45399-P
101-105	45400		
106-110	45403		
111-115	45404		
116-120	45407		
121-125	45408		
126-130	45409		
131-135	45426		
136-140	45427		
141-145	45428		
146-150	45429		
151-155	45430		
161-160	45434		
191-195	45618		
216-220	45442		
321-325	45447		

CORRIDOR SIGNS



Corridor signs feature plastic engraved plates affixed to a wall mounted bracket at a right angle. This design ensures your message is visible from both directions.

Features

- Brackets accommodate inserts up to 1/8" thickness..
- Available with double-sided and single-sided plates (1/16" thickness)
- Thickness Options:

1/16" 1/8"



Plastic Insert Color Options:

Please see page 60 for available insert options

Bracket Colors:

- Gold
- Black
- Rose Gold
- Silver



The displayed prices are applicable to 1/16" thick material only.

For sizes not shown, please contact us for a quote.

Item #	Description	Insert Size	MSRP
45302	Double-Sided Sign w/ Bracket	2" x 8"	\$32.00
45303	Single-Sided Sign w/ Bracket	2" x 8"	\$23.00
45304	Double-Sided Sign ONLY	2" x 8"	\$22.00
45305	Double Sided Sign w/ Bracket	2" x 10"	\$33.00
45306	Single-Sided Sign w/ Bracket	2" x 10"	\$24.00
45307	Double-Sided Sign ONLY	2" x 10"	\$23.00
45618	Double-Sided Sign w/ Bracket	2" x 12"	\$43.00
45619	Single-Sided Sign w/ Bracket	2" x 12"	\$30.00
45620	Double-Sided Sign ONLY	2" x 12"	\$33.00
45621	Double-Sided Sign w/ Bracket	3" x 10"	\$44.00
45622	Single-Sided Sign w/ Bracket	3" x 10"	\$30.00
45623	Double-Sided Sign ONLY	3" x 10"	\$34.00
45624	Double-Sided Sign w/ Bracket	3" x 12"	\$48.00
45627	Single-Sided Sign w/ Bracket	3" x 12"	\$33.00
45628	Double-Sided Sign ONLY	3" x 12"	\$38.00

FULL COLOR SIGNAGE



Eye-catching, full-color graphics are directly printed onto plastic, ensuring signage that truly commands your attention.

Features

- Sizes: Up to 24" x 48"
- UV Ink is resistant to scratches and fading.
- Weatherproof.
- PMS color matching available.
- Thickness Options:
1/16"



The displayed prices are applicable to 1/16" thick material only.

Square Inches	Full Color Wall Sign	MSRP
1-5	45380-C	\$11.50
6-10	45381-C	\$12.50
11-15	45382-C	\$13.50
16-20	45383-C	\$14.50
21-25	45384-C	\$17.40
26-30	45385-C	\$19.25
31-35	45386-C	\$21.10
36-40	45387-C	\$22.95
41-45	45388-C	\$24.75
46-50	45389-C	\$26.65
51-55	45390-C	\$28.45
56-60	45391-C	\$30.30
61-65	45392-C	\$32.15
66-70	45393-C	\$33.95
71-75	45394-C	\$35.85
76-80	45395-C	\$37.65
81-85	45396-C	\$39.50
86-90	45397-C	\$41.35
91-95	45398-C	\$43.20
96-100	45399-C	\$45.00
101-105	45400-C	\$46.85
106-110	45403-C	\$48.70
111-115	45404-C	\$50.55
116-120	45407-C	\$52.40
121-125	45408-C	\$54.25
126-130	45409-C	\$56.00
131-135	45426-C	\$57.90
136-140	45427-C	\$59.75
141-145	45428-C	\$61.55
146-150	45429-C	\$63.40
151-155	45430-C	\$65.25
161-160	45434-C	\$67.85
191-195	45618-C	\$80.00
216-220	45442-C	\$110.20
321-325	45447-C	\$161.45

Material Colors:

- Gold Plastic
- Silver Plastic
- White Plastic



An art fee will be charged if production ready art is not provided.



For 1/8" material and sizes not shown, Please contact us for a quote.

APPLIQUÉ SIGNAGE



In this process, laser-cut tactile letters and graphics, known as “appliqué” are applied to the sign substrate with the corresponding insert braille beads.

Allows you to adhere to the Americans with Disabilities Act.

Features

- Traditional ADA Sign Solution.
- Can be used on a variety of approved substrates.
- Thickness Options:

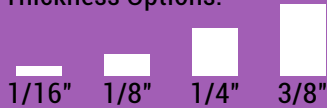

For more details and pricing on Applique Signage, Please contact us for a quote.

3D PRINTED SIGNAGE



In this process, vibrant, full color graphics are 3D printed directly on a variety of substrates including plastic, acrylic, and aluminum.

Features

- Crisp, superior printing.
- UV Ink resistant to scratches and fading.
- Weatherproof.
- PMS color matching available.
- Thickness Options:

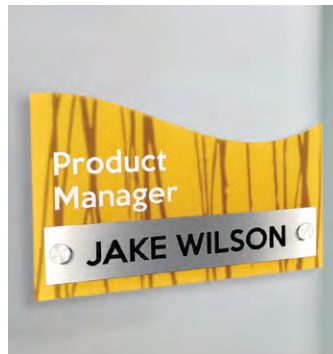
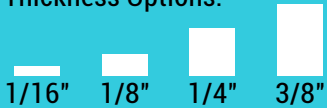

For more details and pricing on 3D Printed Signage, Please contact us for a quote.

We create an assortment of custom signage for your interior spaces. Explore the different types below.

DIRECTIONAL

Directional signage provides accurate and easy to understand directions to guide people to their destination as simply as possible.

Using directional signs help make your building easy to navigate with simple to read signage that inform, reinforce your brand, and help improve traffic flow.



IDENTIFICATION

Identification signage is a style of signage that clearly marks a particular area and indicates that you have arrived at a location.

Typically these signs specify the name or number of a room or the entrance to a department or office. They are generally placed adjacent to doorway entrances and most often ADA compliant.



REGULATORY

Regulatory signage is the foundation for creating a safe environment.

Primarily ADA compliant, regulatory signage is focused on safety and liability concerns. They display a clear, concise, and prominent message and are used to establish and reinforce rules, safety standards, and privacy expectations.

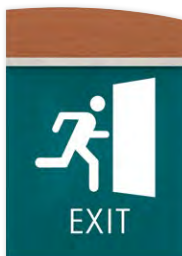

FROM WAYFINDING TO ROOM IDENTIFICATION, INTERIOR SIGNAGE IS KEY TO DELIVERING ESSENTIAL INFORMATION TO YOUR VISITORS. WE CAN HELP YOU WITH CREATING A SINGLE PIECE TO AN ENTIRE SIGNAGE ROLLOUT.

INFORMATIONAL

Informational signage pertains to the overall facilities and provide visitors with broad information such as hours of operation, amenities, and business policies that they need while navigating.

The use of informational signage should answer questions before they're asked and be universally understandable at a glance.



DIRECTORY

Directory signage is absolutely essential for every kind of building and enables your visitors to easily locate and navigate to the correct location within your facility.

Do you need to make changes frequently to your directory signs? We offer directory styles that can quickly be switched out as needed.



WINDOW & INSERT

Window and Insert signage is a highly versatile signage option for practically any facility.

These signs are ideal for displaying both permanent information (room numbers or room names) and adjustable information that may need to be updated occasionally (staff names, schedules, or other items).

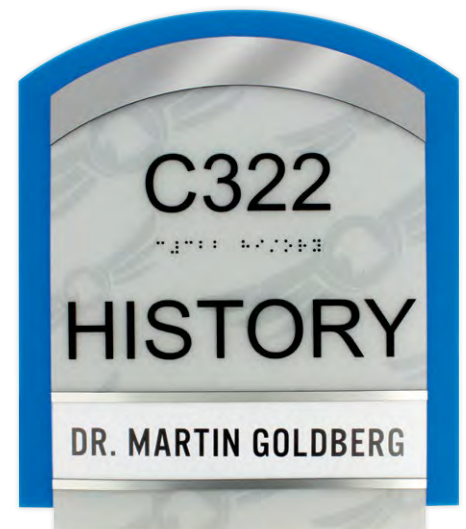
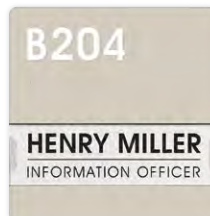

Explore Schwaab's Signage Collection!

Designed to take the hassle out of creating a sign, our signage collection makes it very easy to create a cohesive and distinctive signage system that enhances any décor and suits any budget.

Denali SERIES

shown in

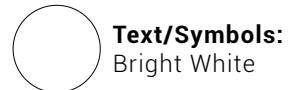

Alternative Color Combinations To Try:



Backer: Air Force Blue
Accent: Brushed Aluminum
Text/Symbols: Bright White



Backer: White
Accent: European Gold
Text/Symbols: Black



Backer: Black
Accent: Brushed Aluminum
Text/Symbols: Bright White



Backer: China Blue
Accent: European Gold
Text/Symbols: White



Backer: Burgundy
Accent: Brushed Aluminum
Text/Symbols: Bright White



Avala SERIES

shown in

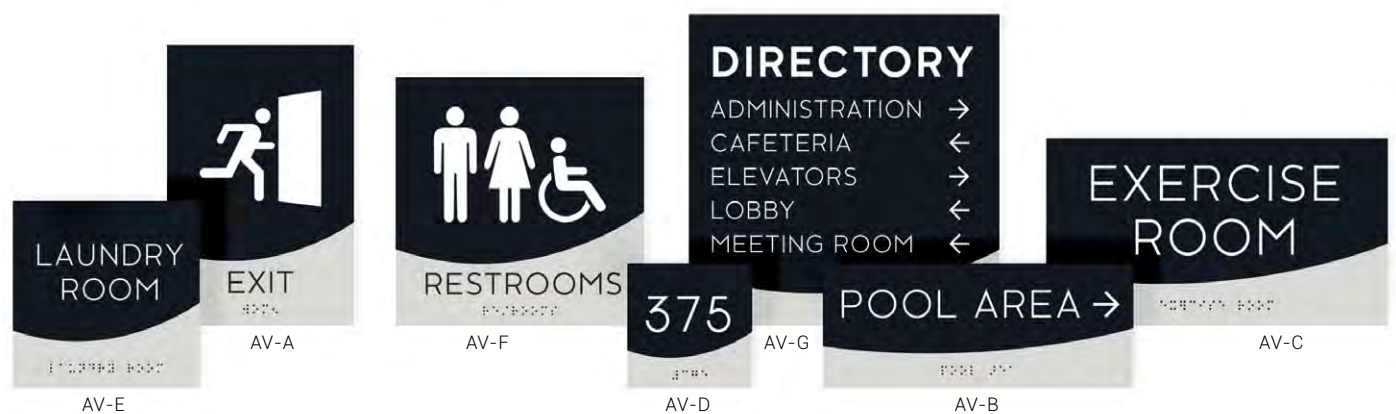
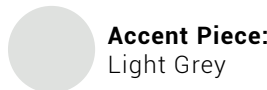
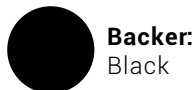

Alternative Color Combinations To Try:



Backer: Grey Flannel
Accent: Black
Text/Symbols: Bright White



Backer: Marine Blue
Accent: Pearl Grey
Text/Symbols: Brt White/Black



Backer: Candlewick
Accent: Black
Text/Symbols: Brt White/Black



Backer: Coastal Blue
Accent: Sandalwood
Text/Symbols: White/Black



Backer: Slate
Accent: Light Grey
Text/Symbols: Brt White/Black

CHOOSE FROM A SIZE BELOW OR WE CAN CREATE A CUSTOM SIZE FOR YOU!

- A** 6" x 9" **B** 10" x 4" **C** 11" x 6" **D** 4" x 4" **E** 6" x 6" **F** 8" x 8" **G** 10" x 10"

Shasta SERIES

shown in



Backer:
Glacier



Face:
Bright White



Text/Symbols:
Black

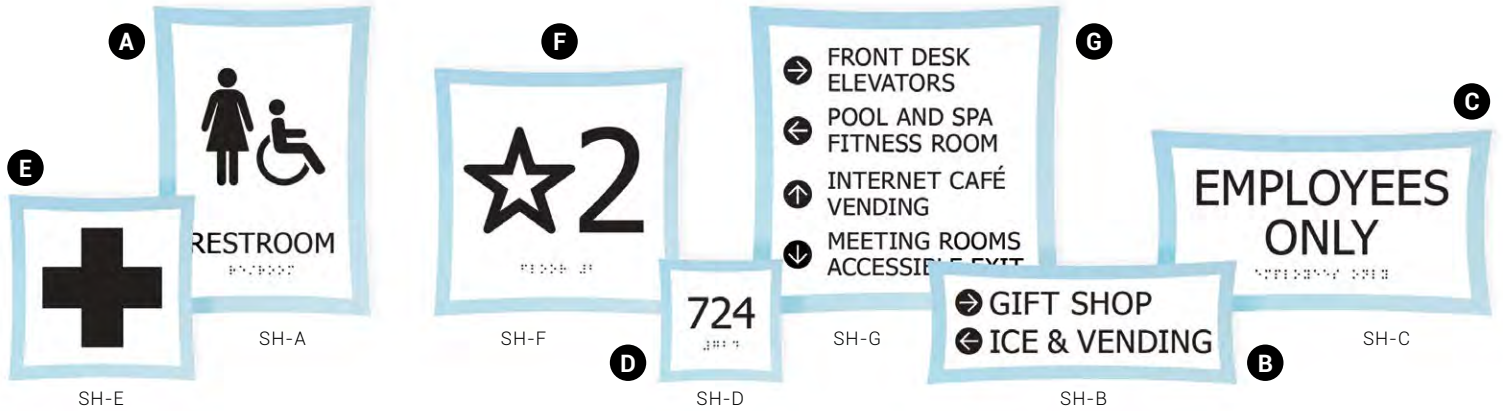

Alternative Color Combinations To Try:

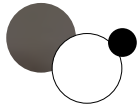

Backer: Smoke
Face: Bright White
Text/Symbols: Black

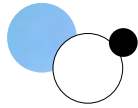

Backer: Wedgewood
Face: Bright White
Text/Symbols: Black

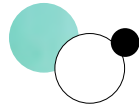

Backer: Caribbean
Face: Bright White
Text/Symbols: Black

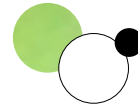

Backer: Kiwi
Face: Bright White
Text/Symbols: Black

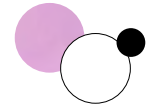

Backer: Wisteria
Face: Bright White
Text/Symbols: Black

Cascade SERIES

shown in



Backer:
Deep Bronze



Face:
China Blue



Text/Symbols:
Bright White

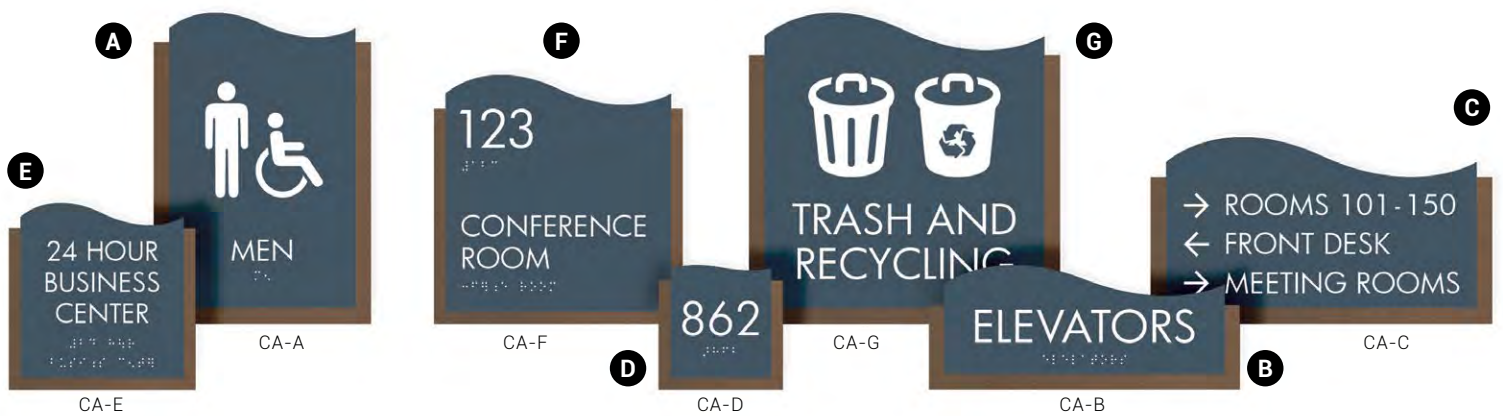

Alternative Color Combinations To Try:



Backer: Sand
Face: Slate
Text/Symbols: Bright White



Backer: Cinder
Face: Putty
Text/Symbols: Bright White



Backer: Light Grey
Face: Pine Green
Text/Symbols: Bright White

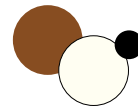

Backer: Copper
Face: White
Text/Symbols: Black



Backer: Graphite
Face: Burgundy
Text/Symbols: Bright White

VISIT THESE HELPFUL PAGES FOR YOUR DESIGN OPTIONS

- 41 COPY STYLES
- 42 SYMBOLS
- 43 COLOR CHARTS

Upgrade with Standoffs



Alpine SERIES

shown in

Backer: Cinder

Face: Coastal Blue

Text/Symbols: Bright White

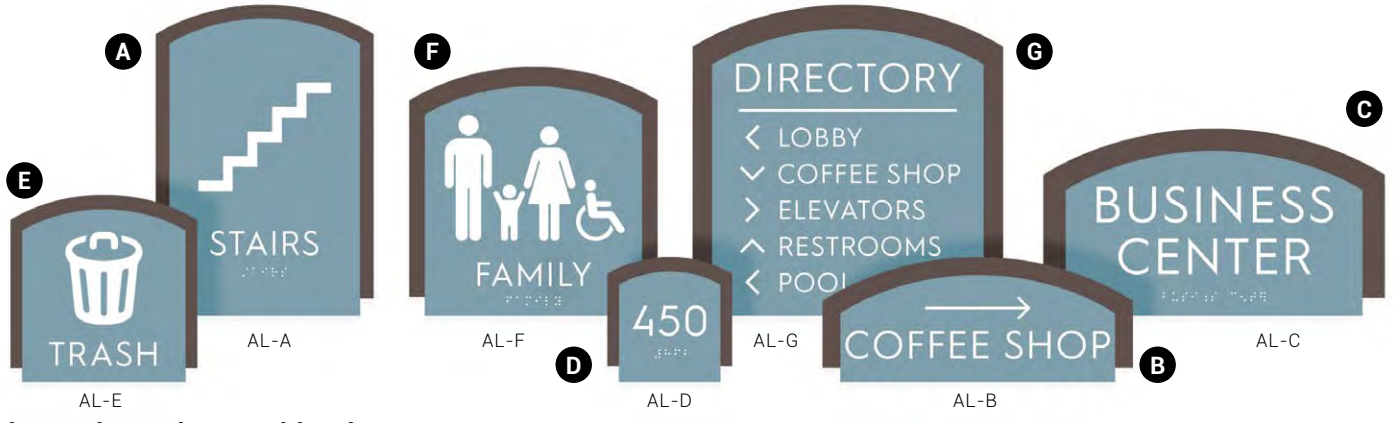

Alternative Color Combinations To Try:

Backer: Silver Face: Black Text/Symbols: Bright White	Backer: Graphite Face: Ash Text/Symbols: Black	Backer: Copper Face: Marine Blue Text/Symbols: Bright White	Backer: Canyon Face: Taupe Text/Symbols: Bright White	Backer: Light Grey Face: Charcoal Grey Text/Symbols: Bright White

Olympus SERIES

shown in

Backer: Sand

Face: Airforce Blue

Text/Symbols: Bright White



Alternative Color Combinations To Try:

Backer: Copper Face: Dark Brown Text/Symbols: Bright White	Backer: Charcoal Grey Face: Black Text/Symbols: Bright White	Backer: Light Grey Face: Coastal Blue Text/Symbols: Bright White	Backer: Taupe Face: Canyon Text/Symbols: Bright White	Backer: Gold Face: China Blue Text/Symbols: Bright White

CHOOSE FROM A SIZE BELOW OR WE CAN CREATE A CUSTOM SIZE FOR YOU!



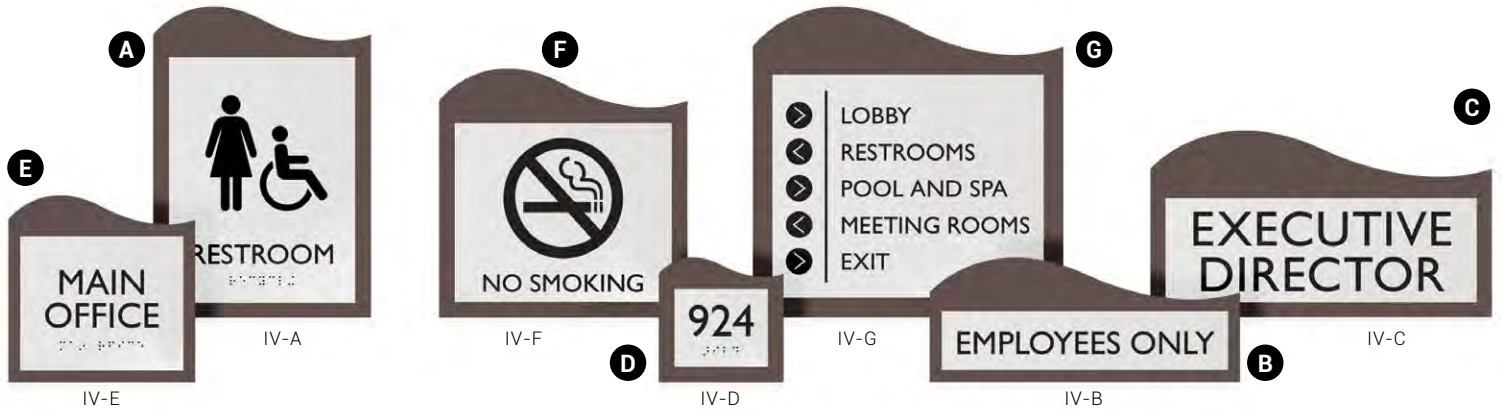

- A** 6" x 9" **B** 10" x 4" **C** 11" x 6" **D** 4" x 4" **E** 6" x 6" **F** 8" x 8" **G** 10" x 10"

Ives SERIES

shown in  **Backer:** Cinder  **Face:** Phantom  **Text/Symbols:** Black

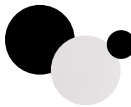

Alternative Color Combinations To Try:



-  **Backer:** Sapphire
Face: Phantom
Text/Symbols: Black
-  **Backer:** Taupe
Face: Phantom
Text/Symbols: Black
-  **Backer:** Black
Face: Phantom
Text/Symbols: Black
-  **Backer:** Coastal Blue
Face: Phantom
Text/Symbols: Black
-  **Backer:** Black Forest Green
Face: Phantom
Text/Symbols: Black

Cheviat SERIES

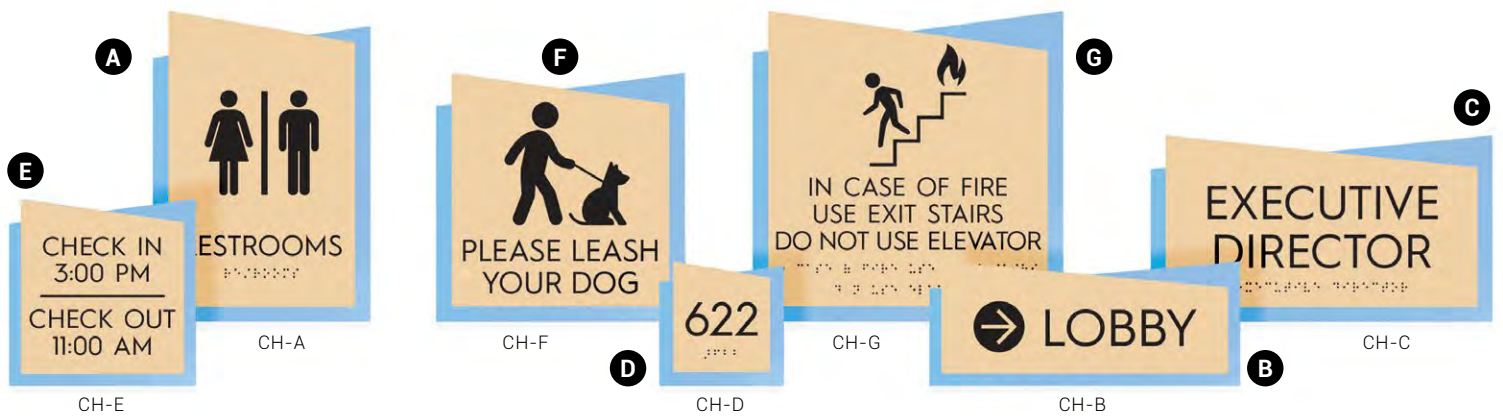
shown in  **Backer:** Wedgewood  **Face:** Desert Sand  **Text/Symbols:** Black



Alternative Color Combinations To Try:

-  **Backer:** Caribbean
Face: Light Grey
Text/Symbols: Black
-  **Backer:** Daffodil
Face: White
Text/Symbols: Black
-  **Backer:** Phantom
Face: Coastal Blue
Text/Symbols: Bright White
-  **Backer:** Smoke
Face: Bright White
Text/Symbols: Black
-  **Backer:** Wisteria
Face: White
Text/Symbols: Black

Stock ADA Signs

ADA SIGNAGE PLAYS A CRITICAL ROLE IN MAKING YOUR FACILITY ACCESSIBLE.

WITH RAISED PICTOGRAMS AND GRADE II BRAILLE, OUR STOCK DESIGNS COMPLY WITH ADA REGULATIONS AND ARE A GREAT SOLUTION FOR TEMPORARY SIGNAGE!



Men's Restroom
ADA01



Men's Accessible Restroom
ADA02



Women's Restroom
ADA03



Women's Accessible Restroom
ADA04



Unisex Restroom
ADA05



Unisex Accessible Restroom
ADA06



All Gender Accessible Restroom
ADA07



Exit
ADA08



Baby Changing Area
ADA09

In Stock and Ready to Ship!

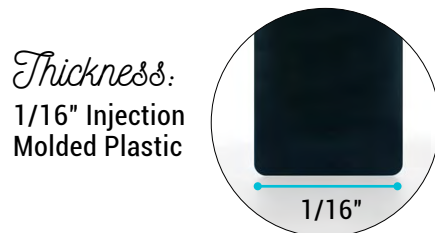
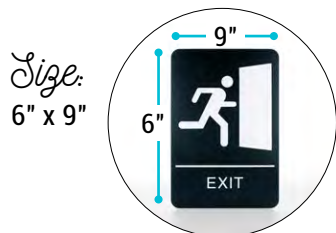

Classic Engraved Stock Signs

READY FOR IMMEDIATE SHIPMENT,
THESE ENGRAVED PLASTIC SIGNS ARE THE
PERFECT WAY TO PROVIDE INFORMATION, DIRECTIONS,
AND ASSISTANCE IN ANY OFFICE OR BUSINESS.



Tabletop Signs

- Dimensions: 3" x 8"
- Available in your choice of Pedestal or Tent Style.



Tent Style

- Item 45315-(style #)

Style #	Message
---------	---------

Style 1	Closed
Style 2	No Smoking
Style 3	No Smoking (w/ Image)
Style 4	Please Use Next Window
Style 5	Reserved
Style 6	Please Ring Bell for Assistance
Style 7	Authorized Personnel Only
Style 8	Do Not Enter
Style 9	Employees Only
Style 10	Food & Beverage Prohibited
Style 11	Food & Beverage Prohibited (w/ Image)
Style 12	No Cell Phone Use (w/ Image)
Style 13	No Loitering
Style 14	No Pets Allowed
Style 15	No Pets Allowed (w/ Image)
Style 16	Receptionist
Style 17	All Visitors Must Register at Office
Style 18	Welcome!
Style 19	No Soliciting
Style 20	No Visitors
Style 21	Private
Style 22	Smoking Area
Style 23	Thank You For Not Smoking
Style 24	Employees Must Wash Hands



Pedestal Style

- Item 45317-(style #)

Available Color Combinations:

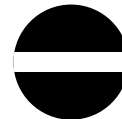

BLACK
Core: White



RED
Core: White



SAPPHIRE BLUE
Core: White

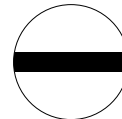

WHITE
Core: Black



BRUSHED GOLD
Core: Black



BRUSHED SILVER
Core: Black

Wall Signs

- Dimensions: 2" x 8"
- Display your sign in a wall or desk holder (sold separately)
See page 60 for options.

Item #	Message	Surface Color	Letter Color
--------	---------	---------------	--------------

45801	Arrow	Red	White
45803	Employees Only	White	Red
45804	Exit	Black	White
45808	Men	Black	White
45859	No Checks Accepted	White	Red
45812	No Smoking	White	Red
45813	No Solicitors	White	Red
45822	Office	Black	White
45807	Private	Black	White
45819	Pull	Black	White
45817	Push	Black	White
45809	Women	Black	White



Do you prefer to create your own custom sign?

LET'S START DESIGNING! SIMPLY CREATE YOUR BASIC SIGN BY SELECTING YOUR SHAPE, BACKGROUND COLOR, FONT, AND LETTER COLOR. IT'S THAT EASY!

EXAMPLE

Shape: Arch
 Color: Taupe
 Font: Futura
 Copy Color: White



Shape **OPTIONS** ▼

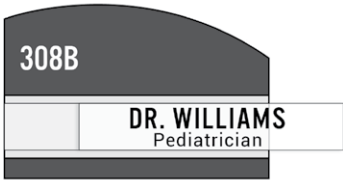
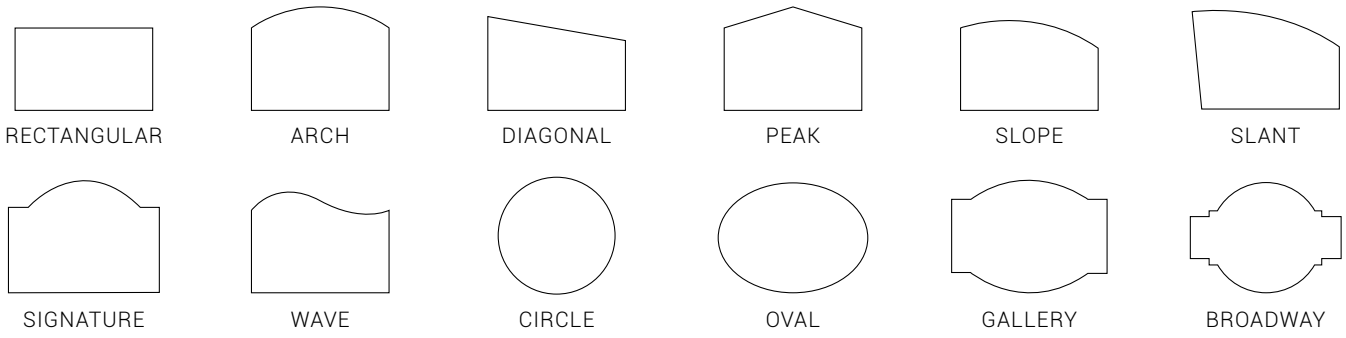

Special **FEATURES**

Window signs with replaceable paper inserts allows you to change names with ease.

We offer custom plastic, reverse engraved, brass engraved, ADA, layered, accented, stand-off, framed, window, and changeable message options for signs.

Want something unique? We customize! Speak with one of our consultants to help create the sign you're imagining today.

Choose **YOUR OPTIONAL ENHANCEMENTS!** ▼



Need some Ideas? Start with one of our Layout Templates.

BEGIN BY SELECTING FROM ONE OF THESE TEMPLATES, THEN EASILY CUSTOMIZE BY ADDING YOUR INFORMATION TO MAKE IT ALL YOUR OWN!

VISIT THESE HELPFUL PAGES FOR DESIGN OPTIONS:

57 COPY STYLES

58 SYMBOLS

59 COLOR CHARTS

RECTANGULAR ARCH DIAGONAL PEAK SLOPE SLANT SIGNATURE WAVE CIRCLE OVAL GALLERY BROADWAY

SINGLE BACKER

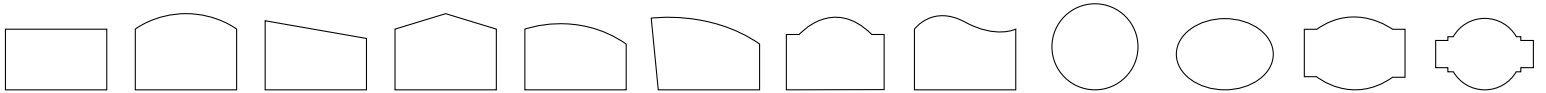

SINGLE BACKER WITH PRINTED BACKGROUND

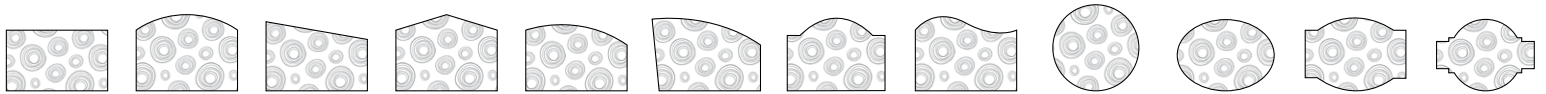

SINGLE BACKER WITH ACCENT PIECE

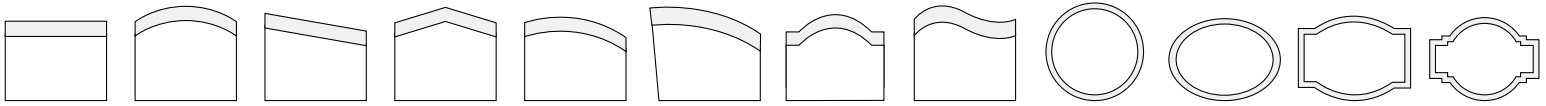

SINGLE BACKER WITH STANDOFFS

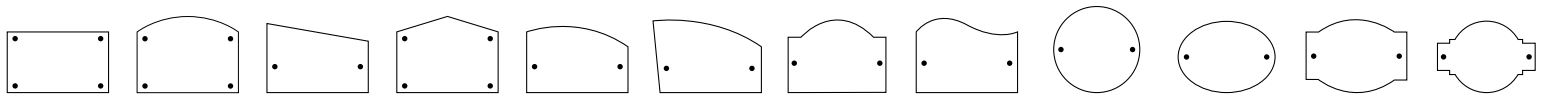

DOUBLE BACKER

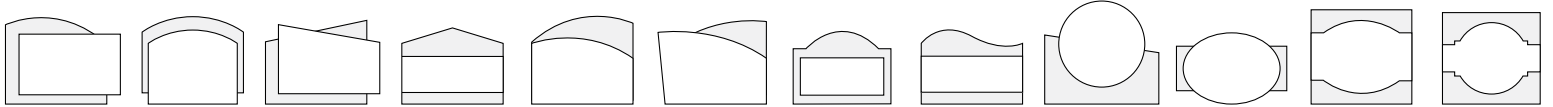

DOUBLE BACKER WITH PRINTED BACKGROUND

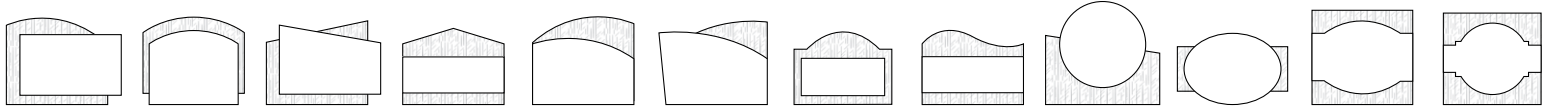

DOUBLE BACKER WITH ACCENT PIECE

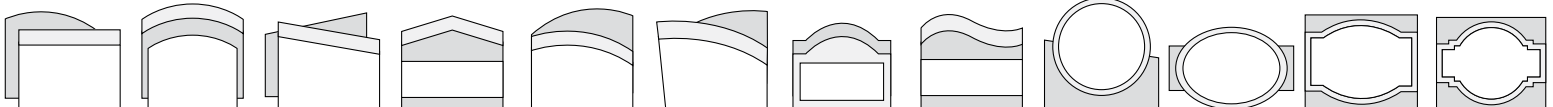

DOUBLE BACKER WITH STANDOFFS

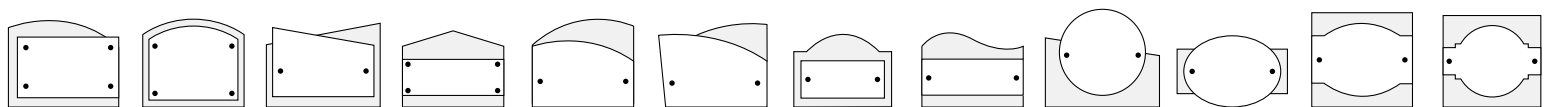

Copy Styles ▶ ADA Compliant Type

This list displays a sample of ADA-compliant fonts for both tactile and visual characters that comply with the 2010 Standards for enhanced readability of tactile signage elements. Looking for another ADA-compliant copy style? Call us to discuss other available options.

Arial
ABCDEFGHIJKLMNOPQRSTUVWXYZ
abcdefghijklmnopqrstuvwxyz
1234567890

Avant Garde
ABCDEFGHIJKLMNOPQRSTUVWXYZ
abcdefghijklmnopqrstuvwxyz
1234567890

Calibri
ABCDEFGHIJKLMNOPQRSTUVWXYZ
abcdefghijklmnopqrstuvwxyz
1234567890

Folio Light
ABCDEFGHIJKLMNOPQRSTUVWXYZ
abcdefghijklmnopqrstuvwxyz
1234567890

Franklin Gothic Book
ABCDEFGHIJKLMNOPQRSTUVWXYZ
abcdefghijklmnopqrstuvwxyz
1234567890

Frutiger
ABCDEFGHIJKLMNOPQRSTUVWXYZ
abcdefghijklmnopqrstuvwxyz
1234567890

Futura Book
ABCDEFGHIJKLMNOPQRSTUVWXYZ
abcdefghijklmnopqrstuvwxyz
1234567890

Futura Medium
ABCDEFGHIJKLMNOPQRSTUVWXYZ
abcdefghijklmnopqrstuvwxyz
1234567890

Gill Sans
ABCDEFGHIJKLMNOPQRSTUVWXYZ
abcdefghijklmnopqrstuvwxyz
1234567890

Helvetica
ABCDEFGHIJKLMNOPQRSTUVWXYZ
abcdefghijklmnopqrstuvwxyz
1234567890

Hurme
ABCDEFGHIJKLMNOPQRSTUVWXYZ
abcdefghijklmnopqrstuvwxyz
1234567890

Interstate
ABCDEFGHIJKLMNOPQRSTUVWXYZ
abcdefghijklmnopqrstuvwxyz
1234567890

Meta Book Roman
ABCDEFGHIJKLMNOPQRSTUVWXYZ
abcdefghijklmnopqrstuvwxyz
1234567890

Metropolis
ABCDEFGHIJKLMNOPQRSTUVWXYZ
abcdefghijklmnopqrstuvwxyz
1234567890

Myriad Pro
ABCDEFGHIJKLMNOPQRSTUVWXYZ
abcdefghijklmnopqrstuvwxyz
1234567890

Rotis
ABCDEFGHIJKLMNOPQRSTUVWXYZ
abcdefghijklmnopqrstuvwxyz
1234567890

Tahoma
ABCDEFGHIJKLMNOPQRSTUVWXYZ
abcdefghijklmnopqrstuvwxyz
1234567890

Trade Gothic
ABCDEFGHIJKLMNOPQRSTUVWXYZ
abcdefghijklmnopqrstuvwxyz
1234567890

U.S. 101
ABCDEFGHIJKLMNOPQRSTUVWXYZ
ABCDEFGHIJKLMNOPQRSTUVWXYZ
1234567890

Verdana
ABCDEFGHIJKLMNOPQRSTUVWXYZ
abcdefghijklmnopqrstuvwxyz
1234567890

Symbol Options ▶ Common Pictograms

Find the perfect pictogram for your signage project!
 This guide displays a variety of common symbols used on ADA signage.
 If your project requires a symbol not shown, please contact your signage consultant.



UNISEX



UNISEX ACCESSIBLE



WOMEN



WOMEN'S ACCESSIBLE



MEN



MEN'S ACCESSIBLE



ALL GENDER RESTROOM



FAMILY ACCESSIBLE



GENDER NEUTRAL



HANDICAP



GIRLS STYLE 1



GIRLS ACCESSIBLE STYLE 1



BOYS STYLE 1



BOYS ACCESSIBLE STYLE 1



GIRLS STYLE 2



GIRLS ACCESSIBLE STYLE 2



BOYS STYLE 2



BOYS ACCESSIBLE STYLE 2



TOILET



STAIRS



STAIRS/FIRE



ELEVATOR



EXIT



NY / CT ACCESSIBLE



FIRST AID



LACTATION ROOM



BABY



MEDICAL



EYE WASH STATION



SHOWER



AED

AED



DO NOT ENTER



NO SMOKING



NO E-CIGARETTES



SMOKING AREA



NO WEAPONS



NO FOOD OR DRINK



NO MOBILE PHONES



INFORMATION



STOP



TDD TELEPHONE



TELEPHONE VOLUME CONTROL



TELEPHONE



DEAF



GENDER INCLUSIVE



ELECTRICAL



FIRE EXTINGUISHER



HOSE EXTINGUISHER



VIDEO SURVEILLANCE



STORM SHELTER



SHELTER IN PLACE



RECYCLE



DRINKING FOUNTAIN



JANITORIAL



PET



COAT ROOM



LOST & FOUND



VENDING



ARROW STYLE 1



ARROW STYLE 2



ARROW STYLE 3



ARROW STYLE 4



ARROW STYLE 5

Color Charts ▶ Find just the Right Color!

ADA Alternative® | Substrate & Appliqué

This matte finished product complies with the federal regulations for tactile signage in the Americans with Disabilities Act (ADA), and comes in a variety of colors to match any project.

THICKNESS OPTIONS: 1/32", 1/16", 1/8", 1/4" (*select colors)

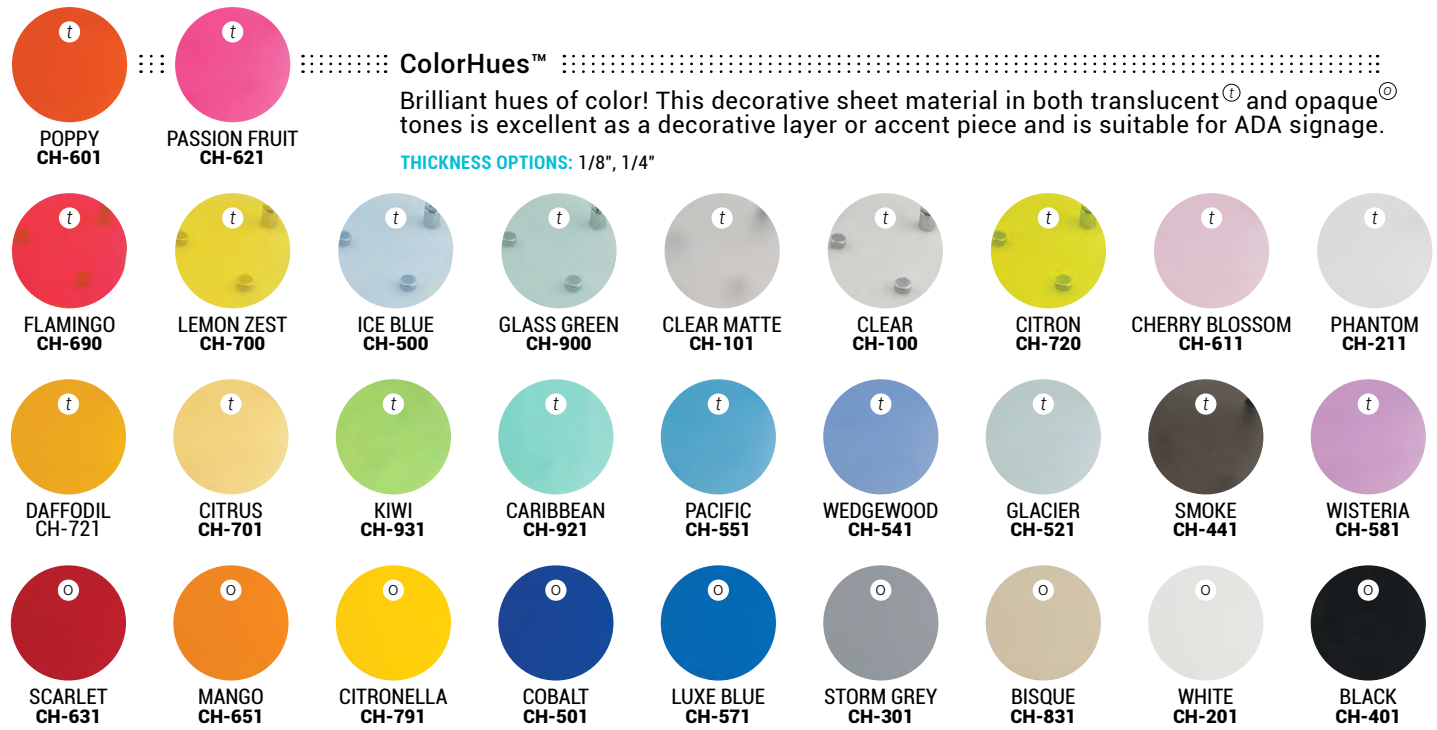
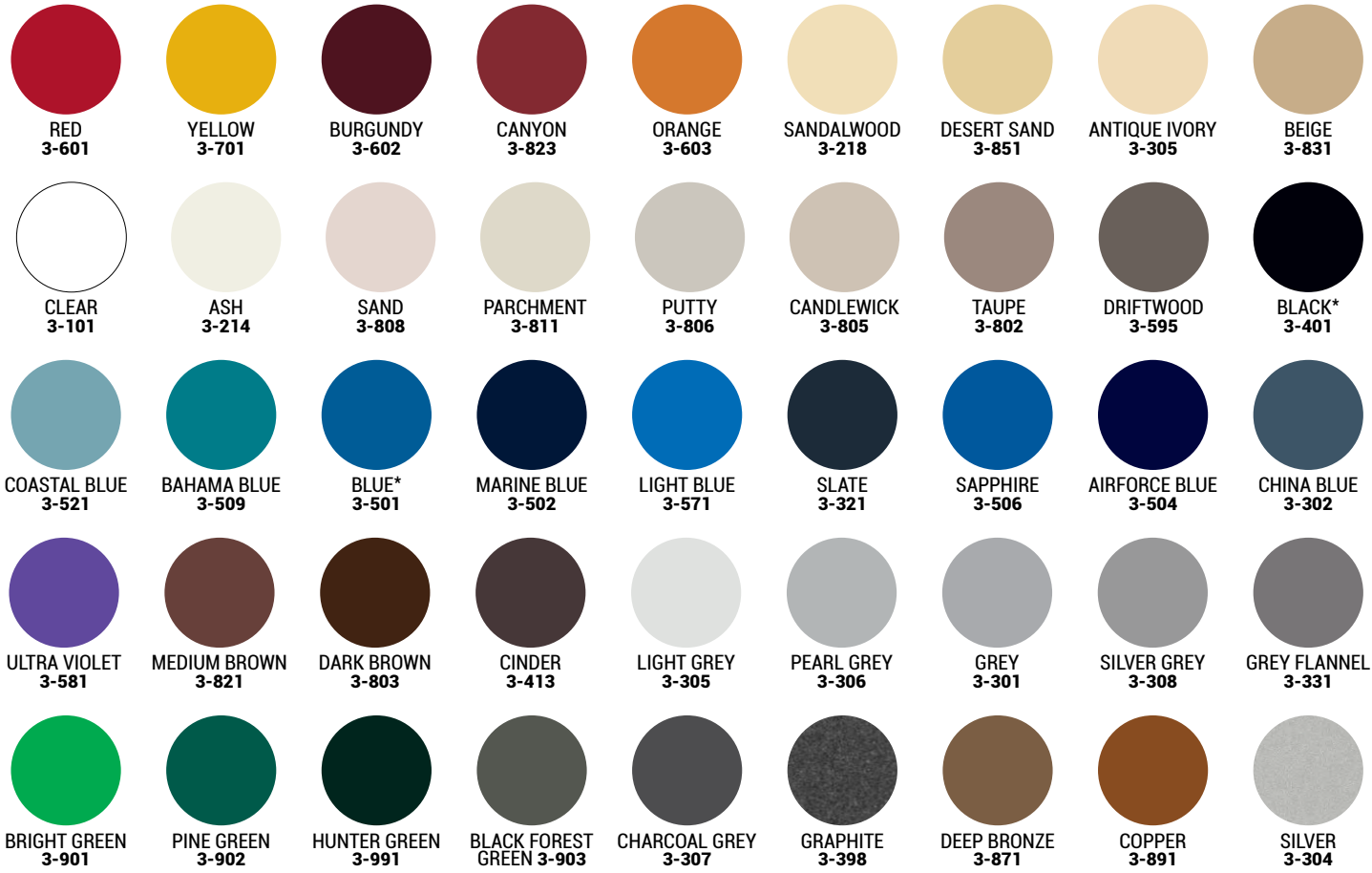
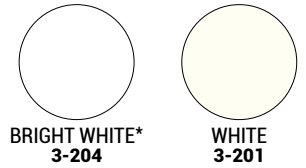

We do our best to ensure that our photos are as true to color as possible and representative of the actual material colors, but please note that colors may vary.

Thickness Options

1/32" 1/16" 1/8" 1/4"

Metallics (core color : black)

Incorporating the look of metal, this variety of plastic substrates is perfect for front engraved signs, decorative layers, & accent pieces.

THICKNESS OPTIONS: 1/32", 1/16"

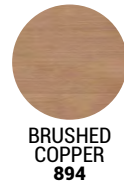

The Naturals (see swatch for core color)

Featuring the contemporary look and feel of marble, granite and wood, this collection is idea for all types of signage including front engraved, decorative layers and accent pieces. THICKNESS OPTIONS: 1/16", 1/8"

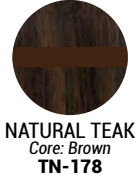

Engraved

This high quality & durable 2-Ply material comes in many colors and is a perfect surface for interior signs, desk plates, & name badges. THICKNESS OPTIONS: 1/16", 1/8"

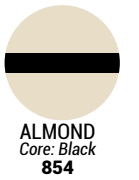
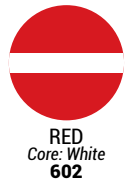
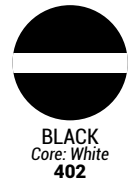

Trodat Replacement Pads (all pads are sold individually.)

Trodat Printy

ITEM	MODEL
46019P	Trodat 46019
46030-2P	Trodat 46130
46040-2P	Trodat 46140
46045-2P	Trodat 46145
46140P	Trodat 46140
46145P	Trodat 46145
4642P	Trodat 4642
4750P	Trodat 4750
4817P	Trodat 4817, 4813, 4917
4850P	Trodat 4850
4910P	Trodat 4910
4911P	Trodat 4911, 4800, 4820
4912P	Trodat 4912, TYPO4912
4913P	Trodat 4913
4914P	Trodat 4914
4915P	Trodat 4915
4916P	Trodat 4916
4918P	Trodat 4918
4923P	Trodat 4923
4924P	Trodat 4924, 4724
4925P	Trodat 4925
4926P	Trodat 4926, 4726
4927P	Trodat 4927, 4727
4928P	Trodat 4928
4929P	Trodat 4929, 4729

Trodat Professional

ITEM	MODEL
50P	Trodat 5200, 5030, 5430, 5546
53P	Trodat 5203, 5440
56P	Trodat 5117, 5204, 5206, 5460, 5558, 55510
55P	Trodat 5205
58P	Trodat 5208, 5474, 5480
511P	Trodat 5211
15P	Trodat 52045

Trodat Professionals

ITEM	MODEL
5030P	Trodat 5030 1 Color
5117P	Trodat 5117 1 Color
5430P	Trodat 5430 1 Color
5430P-2	Trodat 5430 2 Color
5440P	Trodat 5440 1 Color
5440P-2	Trodat 5440 2 Color
5460P	Trodat 5460 1 Color
5460P-2	Trodat 5460 2 Color
5474P	Trodat 5474 1 Color
5474P-2	Trodat 5474 2 Color
5480P	Trodat 5480 1 Color
5480P-2	Trodat 5480 2 Color

ExcelMark Replacement Pads (all pads are sold individually.)

(all pads are sold individually.)

ExcelMark Daters

ITEM	MODEL
462160	ExcelMark 2160 1 Color
462160-2	ExcelMark 2160 2 Color
462360	ExcelMark 2360 1 Color
462360-2	ExcelMark 2360 2 Color
462660	ExcelMark 2660 1 Color
462660-2	ExcelMark 2660 2 Color
462860	ExcelMark 2860 1 Color
462860-2	ExcelMark 2860 2 Color

ExcelMark Stamps

ITEM	MODEL
46A1226-S	ExcelMark 42A1226-S
46A1539-S	Excelmark 42A1539-S
46A1776-S	ExcelMark 42A1776-S
46A1848-S	ExcelMark 42A1848-S
46A2359-S	ExcelMark 42A2359-S
46A3068-S	ExcelMark 42A3068-S
46A4060-S	ExcelMark 42A4060-S
46A4078-S	ExcelMark 42A4078-S
46A4545-S	ExcelMark 42A4545-S
46A12-S	ExcelMark 42A12-S
46A17-S	ExcelMark 42A17-S
46A43-S	ExcelMark 42A43-S
46000-S	ExcelMark 42099

Shiny Replacement Pads (all pads are sold individually.)

Shiny Stamps

ITEM	MODEL
46842	Shiny S842
46843	Shiny S843
46844	Shiny S844
46845	Shiny S845

Shiny Handy Stamps

ITEM	MODEL
46Q32	Shiny Q12
46Q17	Shiny Q17
46S722	Shiny Q12
46S723	Shiny Q12

Aero Ink & Mark II Pads

ITEM	DESCRIPTION	RECOMMENDED SURFACES	INK COLORS	SIZE	ITEM #
Mark II Pad, Dry	Use with Aero 1250 Ink for stamp marking. Reversible pad allows you to flip the pad over when the ink runs dry. Pads are shipped dry.	N/A	N/A	2½" x 4½"	43207
Aero Mark II 1250 Ink	Excellent all purpose, waterproof solvent ink that performs well in all types of application methods. Very fast drying.	Porous, non-porous glossy paper, painted surfaces, metal, wood, electronics, plastic, glass, mylar, vinyl, photos.	● Black ● Blue ● Red ○ White	2 oz. 4 oz. 8 oz. Pint Quart Gallon	42255 43208 43206 42209 42210 42211
Aero Ink Reactivator	Used as a cleaner and thinner for Mark II inks. Reactivates ink pad to extend use. Clean built-up residue on stamp dies.	N/A	N/A	2 oz. 4 oz. 8 oz. Pint Quart Gallon	42256 43209 43205 42212 42213 42214
Aero Ink Kits	Includes a dry Mark II Pad, 2 oz. ink and 2 oz. reactivator.	N/A	● Black ● Blue ● Red ○ White	2 oz.	42257
Aero Indelible Ink	Ideal for fabric and clothing and resists wet and dry cleaning. Fast drying.	Fabric and clothing, porous and non-porous surfaces.	● Black ● Blue ● Yellow ● Red ○ White	2 oz. 8 oz. Pint	42230 42231 42232

Standard Ink Pads

ITEM	DESCRIPTION	NO.	INK COLORS	SIZE	ITEM #
Rubber Stamp Felt Pad	For traditional rubber stamp. Also available dry upon request	No. 0	● Black ● Red	2 1/8" x 3 1/4"	43201
		No. 1	● Blue ● Purple	2 5/8" x 4 1/4"	43202
		No. 3	● Green ● Brown	4 1/4" x 7 1/4"	43204
Industrial Pads	Rugged, High-grade dry pads designed for rigorous use and for extra large rubber stamp applications	4F	N/A	5" x 7"	43219
		3F		2 3/4" x 4 3/8"	43226

Standard Marking Inks

ITEM	APPLICATION	CHARACTERISTICS	RECOMMENDED SURFACES	INCOMPATIBLE SURFACES	DRYING TIME	INK COLORS	SIZE	ITEM #
ExcelMark Premium Stamp Ink	Self Inking Stamps, Self Inking Daters & Rubber Stamp Pads	High performance, water-based stamp ink.	Porous surfaces including non-coated paper.	Fabric, Glossy Paper, Wood, Plastics, Glass, Metal, Photos	Moderate	● Black ● Red ● Blue ● Purple ● Green ● Brown	5 cc 2 oz.	42201 42202
ExcelMark Flash Ink	Flash Stamps & Flash Daters	High performance, oil-based stamp ink.	Porous surfaces including non-coated paper.	Fabric, Glossy Paper, Wood, Plastics, Glass, Metal, Photos	Moderate	● Black ● Red ● Blue ● Purple ● Green	2cc 1/4 oz. 1 oz.	42255 51098 51096
Xstamper Ink	Xstamper Stamps & Daters	High performance, oil-based stamp ink.	Porous surfaces including non-coated paper.	Fabric, Glossy Paper, Wood, Plastics, Glass, Metal, Photos	Moderate	● Black ● Red ● Blue ● Purple ● Lt. Blue ● Orange ● Green ● Yellow ● Lt. Green ● Brown ● Pink	10 ml	50111
						● Black ● Red ● Blue ● Purple ● Green ● Orange ● Lt. Green ● Yellow ● Pink	20 ml	50112
						● Black ● Red ● Blue ● Purple ● Green ● Orange ● Yellow	60 ml	50113
Xstamper Refill Cartridge	Xstamper VersaDaters, 10-in-1 Stamps, Phrase & Number Stamps	High performance, oil-based stamp ink.	Porous surfaces including non-coated paper.	Fabric, Glossy Paper, Wood, Plastics, Glass, Metal, Photos	Moderate	● Black ● Red ● Blue	5 Pack Cartridge	50115
STSG Industrial Refill Ink	Xstamper "F-Series" & Traditional Real Rubber Stamps	Fast drying, permanent and water resistant.	Any slick or hard to mark surface such as metal, glass, leather and glossy paper.	N/A	1,5 - 2 minutes	● Black ● Red ○ White ● Purple ● Blue ● Yellow ● Green ● Solvent	20 ml 60 ml	50113 50114
Numbering Machine Ink	Use with automatic numbering machines with metal wheels	N/A	Porous surfaces, fabric, wood.	Non-porous, Coatings, Wood, Plastic, Glass, Metal, Photos	Very Fast	● Black ● Red	1 oz.	42204
Frozen Food Ink	Rubber Stamp Pads	Imprints well on frozen food packaging, even when moisture is present.	Non-porous surfaces including the outside of food packaging and frozen food packaging.	N/A	30 - 60 seconds	● Black ● Red ● Green ● Violet	8 oz.	42223
Invisible Ink	Rubber Stamp and Felt Pad	Invisible unless exposed to ultra-black light.	Porous surfaces, skin, fabric.	Glossy Paper, Wood, Plastics, Glass, Metal, Photos		○ Clear	4 oz. 8 oz. Pint	42227 42228 42229

The Versatile Signage Solution!

OUR FLOOR AND WALL DECALS ARE PERFECT FOR ADVERTISING, WAYFINDING, COMMUNICATING POLICIES, AND PROMOTING SAFETY.

11 INCH DECAL APPLICATIONS



FLD-SD11-2



FLD-SD11-3



FLD-SD11-1

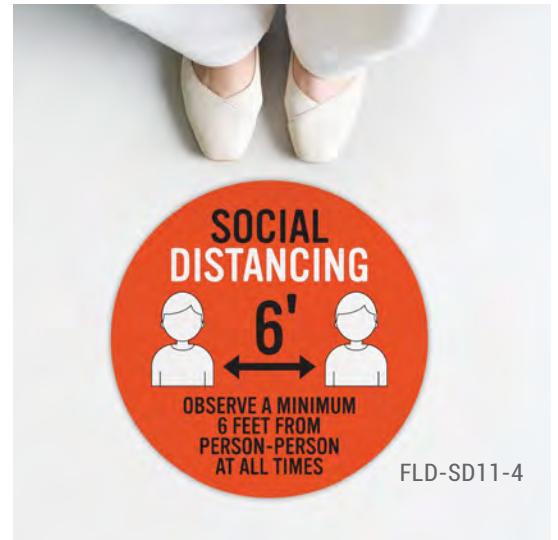

FLD-SD11-4

Social Distancing ▶▶



FLD-ARW7



FLD-SD-DSN19



FLD-ARW3



FLD-ARW8

◀◀ *Traffic Flow*

VINYL STAIRWAY AND WALL DECALS

Easily mix and match our stair & wall decals to direct traffic flow!

Wall Decals: 8" H x 16" L

FLD-SD-DSN22



FLD-SD-DSN23

Stair Decals: 3" H x 16" L

FLD-SD-DSN20



FLD-SD-DSN21



MATERIAL:

High grade polyester floor and wall vinyl.

DECAL FEATURES:

- Multi-Surface Use
- Durable Material
- Anti-Slip Material
- High Scuff Resistance
- Outdoor Use Approved
- Easy Removal

APPLICATION SURFACES:

All smooth hard floors including concrete, tile, laminate, hardwood, and some low pile carpet tiles.

An art fee will be charged if production ready art is not provided.

11" Diameter Decal

Single

5 Pack

10 Pack



TCHR-FLD-11DSN111

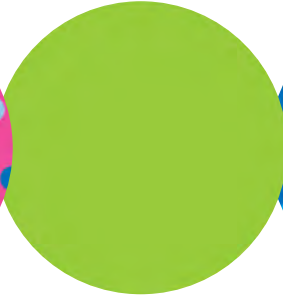

TCHR-FLD-11DSN136



TCHR-FLD-11DSN103

Classroom ▶▶



TCHR-FLD-11DSN41

WH-FLD-11-DSN43



WH-FLD-11-DSN34



WH-FLD-11-DSN55



WH-FLD-11-DSN8



◀◀ *Safety Graphics*

CUSTOM FLOOR DECALS

Do you have a design of your own or would like for us to customize one of our stock designs to complement your branding?

You can order custom decals in any size, shape, and quantity for your business or retail space. Windows, walls, or floor - these durable decals can also be used for seasonal promotions or to add extra branding to your space. Contact us to learn more!



